



THUNDER LASER SYSTEMS



User's manual for NOVA-63

www.thunderlaser.com

tech@thunderlaser.com

February 17, 2017

Original Instruction

Introduction

This manual has been designated as the thunder laser systems, laser cutting machine installation and user guide; The manual is divided into five chapters, Including general information instructions, safety instructions, the key components of every laser cutting systems and the installation steps, operation instructions and maintenance instructions from THUNDERLASER Company.

Frist, it should be emphasized that the installation of each system must meet the requirements, and make it consistent with the installation requirements of THUNDERLASER. If not, the machine will not working properly, poor performance, life shortened, maintenance costs increased and even machine damage .

The note is for getting a specific requirement of system installation, and we hope every customer try to understand these notes before installation and usage, thus you can correctly install and use. If you meet any installation problems, you can contact our technical staff and customer service staff. **(At the same time, you can also refer to the machine installation video that we posted on youtube. The specific URL is**

<http://www.thunderlaser.com/how-to-use-your-laser-machine/how-to-setup-your-nova-laser-cutter.html> Or

<https://www.youtube.com/watch?v=NpLo1LONQx8&list=PLjSZrgjcrhs7QucNN-3jx7rZapDGfjG-5> .)

Contents

Chapter1 General	5
1.1 General Information	5
1.2 Designated	6
1.3 Disposal remarks	6
1.4 Technical Data/Device Specification	7
1.5 Manufacturer's Label	9
Chapter 2 Safety.....	10
2.1 General Safety Information	10
2.2 Laser Safety Information	12
2.3 Safety Precautions When Operating the Device	13
2.4 Warning and Information Labels	14
Chapter 3 Process of Installing	16
3.1 Unpacking	16
3.2 Location.....	17
3.3 Before Installaion	18
3.4 Exhaust System - Requirements	20
3.5 Air System - Requirements.....	20
3.6 Computer - Requirements.....	21
3.7 Connections	22
3.7.1 Connecting the Mains	22
3.7.2 Connecting the Computer	23
3.7.3 Connecting the Exhaust System	24
3.7.4 Connecting the Air System	26
3.7.5 Connecting the Cooling System	27
Chapter 4 Operation	28
4.1 Machine View	28
4.2 ON/OFF Switch	32
4.3 How to use the TL-Timer	33
4.4 How to replace the 4 inch laser head and HR laser head	35
4.5 How to adjust focus distance using manual/auto	37
4.6 How to Use the Display	40
4.6.1 Function of the Buttons	40
4.6.2 The Main Interface.....	42
4.6.3 Speed Key.....	43
4.6.4 Max/Min Power Keys.....	43
4.6.5 Set the Layer Parameters	44
4.6.6 Z/U Key	44
4.6.7 Z Move	45
4.6.8 U Move.....	45
4.6.9 Axis Reset+.....	45
4.6.10 Manual Set+.....	46
4.6.11 Laser Set+	46
4.6.12 Origin Set.....	47



4.6.13 Set Fact Parameters..... 48

4.6.14 Def. Fact Parameters..... 48

4.6.15 Auto Focus 48

4.6.16 Language 48

4.6.17 IP Setup..... 49

4.6.18 Diagnoses..... 49

4.6.19 Screen Origin..... 50

4.6.20 File Key 51

4.6.21 Alarm Information of Display..... 53

4.7 The First Time Running the Laser 54

4.8 Workstation Area Indication 56

4.9 Rotary Engraving Attachment 57

4.10 For Laser Engraving 60

Chapter 5 Maintenance 61

5.1 Cleaning the Laser Machine 61

5.2 Cleaning the Optical Parts 62

 5.2.1 Cleaning the Focus Lens..... 62

 5.2.2 Cleaning the Mirrors 64

 5.2.3 Cleaning Beam Combiner..... 66

5.3 Maintain the X/Y/Z Rails 67

5.4 Check the Beam Path 68

5.5 Change Cooling Water for The Water Chiller..... 69

5.6 Maintenance Plan 70

Chapter1 General

1.1 General Information

Caution:

Please read and follow this Operation Manual carefully, before installation and operation. Damage to persons and/or material can result from not following individual points of the Operation Manual!

Operation of the system is only permitted with equipment and spare parts supplied or listed in the spare parts and consumables lists.

Auxiliary equipment must be adjusted to the base machine (any queries to dealer or manufacturer).

The following symbols are used for easier understanding of the Operation Manual:



Caution: This component is under voltage. In these areas strictly observe the safety instructions regarding electricity. Care is to be taken in particular during maintenance and repair work.



Caution: In this area pay attention to the possible dangers of the laser beam.



Caution: Warning of hand injury



Caution: Indicates the potential for fire danger when operation the laser. Do operate the laser machine when unattended

Tips: Note or information on individual components of the device that simplify the use or make it more understandable.

1.2 Designated

The THUNDER LASER NOVA-63 is used for engraving and cutting of signs, stamps and suchlike.

A wide variety of materials such as rubber, acrylic, coated metal, tin, special steel, anodized aluminum, cork, cardboard, glass, leather, marble, several plastics and wood can be processed on the laser.



1. The engraving process must only be performed with a perfectly adjusted machine.
2. For cutting applications with 100 W the use of the cutting table is absolutely necessary.
3. Use of the system in other areas is against the designated use. The manufacturer does not admit liability for damage to personal and/or equipment resulting from such use.
- 4, The system must only be operated, maintained and repaired, by personnel that are familiar with the designated field of use and the dangers of the machine!
5. Non-observance of the instructions for operation, maintenance and repair described in this Operation Manual excludes any liability of the manufacturer if a defect occurs.
6. Caution when processing conductive materials (carbon fibers), Conductive dust or particles in the ambient air might damage electrical components and lead to short circuits. Bear in mind that those defects are not warranted.

1.3 Disposal remarks



Do not dispose the machine with domestic waste!

Electronic devices have to be disposed according to the regional directives on electronic and electric waste disposal. In case of further questions, please ask your supplier. He might take care of proper disposal.

1.4 Technical Data / Device Specification

Mechanics

Working area	63.0"x 39.4" / 1600 x 1000 mm
Table Size	66.9"x 44.5" / 1700 x 1130 mm
Z Axis Height	9.1 inch / 230 mm
Max. Height of work piece (Motorized Table, Standard laser head)	9.1 inch / 230 mm
Max. Height of work piece (No Motorize Table, Standard Laser head)	1-2.1 inch / 27- 55mm
Max. Engraving speed	39 inch/sec. / 1000 mm/sec. Standard
Cutting speed	depending on material, thickness, laser power
Motor	Easy Servo Motor
Drive	Hybrid Servo Drive
Work piece table	Solid metal (Honey comb table)
Max. load of work piece table	30 kg
Net Weight	370kgs (816lbs)
Lenses available (focal distance)	2, 0"
Focus lens diameter	20mm
Reflector diameter	25mm
Beam combiner diameter	25mm

Dimensions

W x D x H	86.6"x 59.3"x 40.9" / 2200 x 1505 mm x 1040 mm
-----------	--

Max Part Size (W x L x H)

Front Door Closed	66.9"x 44.5"x 10.6" / 1700 x 1130 mm x 230 mm
Pass-Through Door	66.9" x∞" x 1.2" / 1700 x∞mm x 20 mm

Features

Standard:

Red Dot Pointer, Auto Focus, Motorized Table, Pass-Through Door, Air Assist, Water Pump, Exhaust Fan, Honey Comb Table, 2,0"(50.8mm)Focus Lens, Easily Adjustable Home Position, LCD Display, 3D Engraving, "No Water "protection, Emergency Stop, Maintenance mode, Open cover protection, TL-Timer, The warning light.

Optional:

Rotary Attachment, Water Chiller Attachment, High Resolution head (up to 1000DPI, while standard laser head Max is 500DPI), High air compressor set (Includes water filter).

Control System

Laser power	Adjustable from 2 - 70% (typically 12-70%)
Interface Hardware	USB: connect to PC and U-disk Ethernet: connect to PC
Interface Software	RDWorksV8
Operating Modes	Optimized raster, vector, and combined mode
Buffer Memory	128 MB Standards

Laser Equipment

Laser Type	Sealed CO2 Glass Laser Tube
	Laser Power: 80W, 100W, 130W, 150W
Wavelength	10, 6 μ m
Red dot pointer	Laser Power < 5mW
Wavelength	630nm – 680nm

Cooling System

Air Cooling System	Air-Cooled
Water Cooling System	Water Cooled

Electricity, Power, Fuse

Electricity Requirement	110 to 240 volts, 50 or 60 Hz, Single phase
Power consumption	1400W (Assembly 80Watt Laser Tube) 1500W (Assembly 100Watt Laser Tube) 1700W (Assembly 130Watt Laser Tube)
Recommended fuse	15A, 230V (80W/100W Laser Tube) 20A, 115V (80W/100W Laser Tube) and 20A, 230V (130W Laser Tube) 25A, 115V (130W Laser Tube)

Ambient Conditions

Ambient temperature	+15°C to +35°C / 59°F to 95°F
Humidity	40% to max. 70%, not condensing

Laser Safety

Laser class	CDRH Laser Safety Laser Class 2(H) CE compliant FDA approved
-------------	--

1.5 Manufacturer's Label

The manufacturer's label is located on the back of the device (see Figure below).



It is recommended to enter data such as serial number and year of manufacture into the Manufacturer label below so that you always have this data handy if you have problems with your device or require spare parts.

 THUNDER LASER CUTTER		
DONGGUAN THUNDER LASER EQUIPMENT CO.,LTD No.197, Hudong Road, Shatian Town, Dongguan, Guangdong, China		
Rated voltage: Phase: Rated frequency: Full load current: Weight: Lasertype: Model/Type: Serial Number: Manufactured:	<div style="border: 1px solid black; width: 100%; height: 100%;"></div>	Complies with 21 CFR 1040.10 and 1040.11 except for deviations pursuant to Laser Notice No. 50, dated June 24, 2007 This Product Complies With EN 60825-1:2014. Class 2 Laser Product WWW.thunderlaser.com MADE IN CHINA

Chapter 2 Safety

2.1 General Safety Information

All personnel involved in installation, set-up, operation maintenance and repair of the machine, must have read and understood the Operation Manual and in particular the "Safety" section. The user is recommended to generate company-internal instructions considering the professional qualifications of the personnel employed in each case, and the receipt of the instruction/Operation Manual or the participation at introduction/training should be acknowledged in writing in each case.

Safety-conscious of Working

The machine must only be operated by trained and authorized personnel.

The scopes of competence for the different activities in the scope of operating the machine must be clearly defined and observed, so that under the aspect of safety no unclear questions of competence occur. This applies in particular to activities on the electric equipment, which must only be performed by special experts.

For all activities concerning installation, set-up, start-up, operation, modifications of conditions and methods of operation, maintenance, inspection and repair, the switch-off procedures that may be provided in the Operation Manual must be observed.

Safety Information for the User and/or Operating Personnel

1. No working methods are permitted that affect the safety of the machine.
2. The operator must also ensure that no unauthorized persons work with the machine (e.g. by activating equipment without authorization).
3. It is the duty of the operator, to check the machine before start of work for externally visible damage and defects, and to immediately report changes that appear (including behavior during operation) that affect the safety.
4. The user must provide that the machine is only operated in perfect condition.
5. The user must guarantee the cleanness and accessibility at and around the machine by corresponding instructions and controls.
6. Principally, no safety components may be removed or disabled (already here we emphasize the imminent dangers, for example severe burns, loss of eye-sight). If the removal of safety components is required during repair and service, the replacement of the safety components must be performed immediately after completion of the service and repair activities.
7. Preparation, retooling, change of work piece, maintenance and repair activities must only be performed with equipment switched off, by trained personnel.



8. It is forbidden to perform unauthorized modifications and changes to the machine. It is emphasized, that any unauthorized modifications to the machine are not permitted for safety reasons.

2.2 Laser Safety Information



1. To assess the potential dangers laser systems pose, they are classified into 2 safety classes, thunder laser NOVA-63 is a device of class 2. This is guaranteed by the protective housing and the safety installations.
Please note that improper and warranty operation of the device can override the status of Safety class 2 and can cause the emission of harmful radiation.
2. This laser engraving system contains a carbon dioxide (CO₂) laser of class 2 that emits intensive and invisible laser radiation. Without safety precautions the direct radiation or even diffuse reflected radiation is dangerous!
3. Without safety precautions, the following risks exist with exposure to laser radiation:
 - Eyes: Burns to the cornea
 - Skin: Burns
 - Clothing: Danger of fire
4. Never try to modify or disassemble the laser and do not try to start up a system that had been modified or disassembled!
5. Dangerous radiation exposure can result from the use of operation or adjustment equipment other than that described here, and if different operational methods are performed.

2.3 Safety Precautions when Operating the Device

In your thunder laser NOVA-63, a closed safety system is integrated which immediately stop a job when the protection cover is opened. Consequently an incomplete engraving can occur if the cover is opened during operation. Therefore, first press the "PAUSE" button, if you want to interrupt an engraving process.

Please remember the following safety precautions when working with this device:

CO2 Fire extinguishers should be placed near laser

Do not store any flammable materials in the inside of the device. Particularly leftovers of produced materials have to be removed to prevent fire hazard.

Please maintain Free air-flow surrounding this system. At all times, do not cover during operation.

These lasers emit invisible radiation; safety glasses should be worn when maintenance these machines for your protection.

Do not disable limit switches or safety features as this can invalidate warranties and cause damage to you and the machine.

Do not leave the laser unattended when it is working, small scraps can ignite and without supervision can destroy the machine if not checked.

Adjustment of the beam path must be performed only by especially trained personnel. An improper setting can lead to uncontrolled emission of the laser radiation.

Before processing materials the user must verify, whether harmful materials can be generated and whether the filter equipment of the exhaust system is suitable for the harmful materials. We emphasize that it is the responsibility of the user, to consider the national and regional threshold values for dust, fogs and gases when selecting the filters and the exhaust system. (The values for the maximum workplace concentration must not be exceeded.)

PVC (polyvinyl chloride) must under no circumstances be processed with the laser.

Should you have further questions before starting work, please feel free to write us an email at: tech@thunderlaser.com

2.4 Warning and Information Labels



The warning and information labels are attached in such positions of the device that could represent a source of danger during set-up and operation. Therefore, follow the information on the labels. If labels are lost or damaged, they must be replaced immediately.

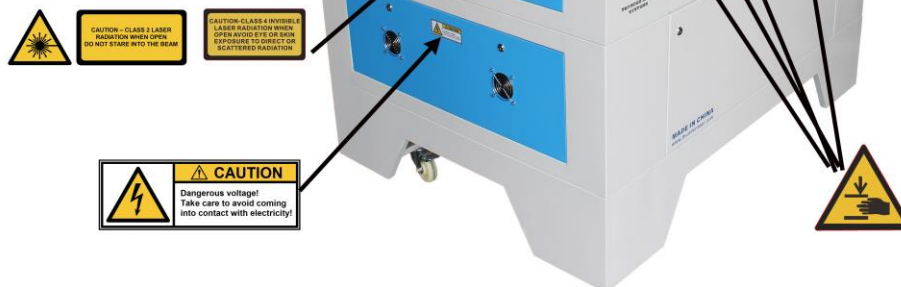
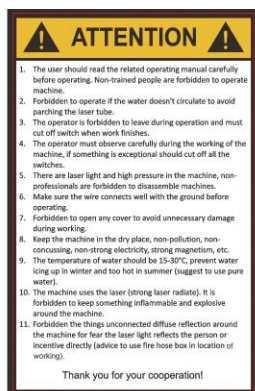
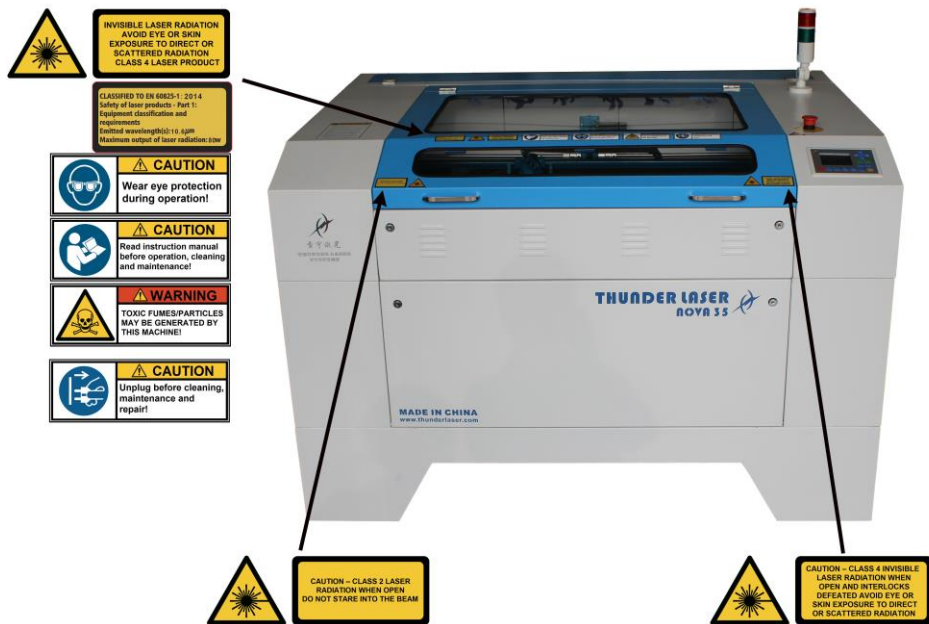

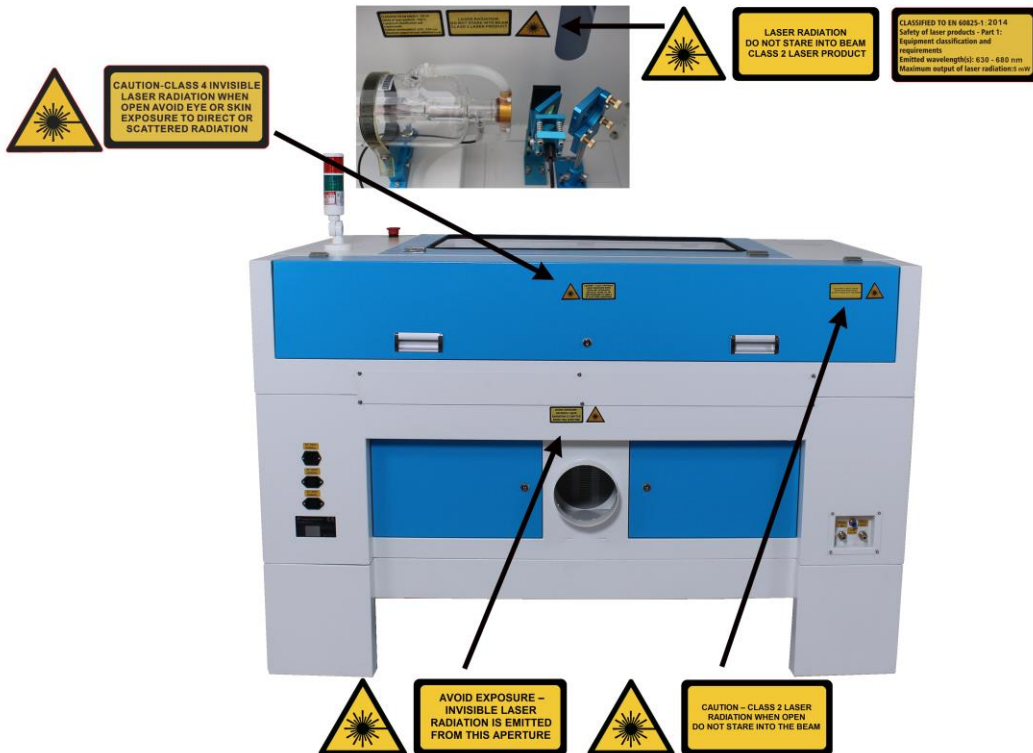

Chapter 3 Process of Installing

3.1 Unpacking

You receive your THUNDER LASER NOVA-63 packed in a wooden box, which contains the laser machine and additional accessories. The following steps give you an overview of the unpacking and assembly of the laser. Please follow these steps carefully.

Tips: Keep the packing box. You will require it in case of a return.

Dispose all waste according to the applicable waste disposal law.

1. Put the wooden box on a flat and spacious room for unpacking.
2. Remove the machine box; carefully remove the foam material, which protects the viewing window of the cover and around the machine.
3. Take out the key, open the door of the laser, Remove the accessories box which contains all accessory parts required for the installation of the laser machine. And check if there's anything damaged or missed during shipping.
4. You will see an attachment table on the machine; please check whether the accessories are all on the table.
5. Please keep the keys and the warranty certificate well (and please show us your warranty certificate if you need tech support for the machine failure, then we will provide you the best technical service).
6. Remove the sponge and nylon cable ties from inside the machine, and then start to install the machine (below chapters are installation details)

3.2 Location

Before you install the laser system, you should select an appropriate location. Follow the guidelines shown below:



1. Avoid locations where the system is exposed to high temperatures, dust and high humidity. (The humidity must not exceed 70% and the temperature must not be close to the dew point.)
2. Avoid locations, where the system is exposed to mechanical shocks.



1. Fuse protection:
Do not connect other devices via the laser fuse, as the laser system requires the full amperage.

Tips:

1. Avoid locations with poor air circulation; select a location close to ventilation (if available).
2. Select a location, whose room temperature is between 15 °C and 25 °C (59° – 77° F). This is fundamental to maintain consistent and reliable operation of a CO2 laser, Metal RF or Glass tube and the machine itself.
Avoid higher ambient temperatures and strong exposure of the engraver to the sun. Use blinds, if required.
3. Mechanical shock and vibration of the laser will have detrimental effects on the performance and life expectancy of the machine. It will manifest (over a period of time) with a noticeable decrease in performance and increased maintenance required, possibly even damage. Setting your Thunder Laser up in a suitable temperature controlled, dust free, moisture free, level, stable surface (a level concrete floor) with the recommended extraction is critical to the ongoing performance of the machine. It is also a warranty condition.

3.3 Before Installation

1. Take out the sponge around the laser tube. Like below:

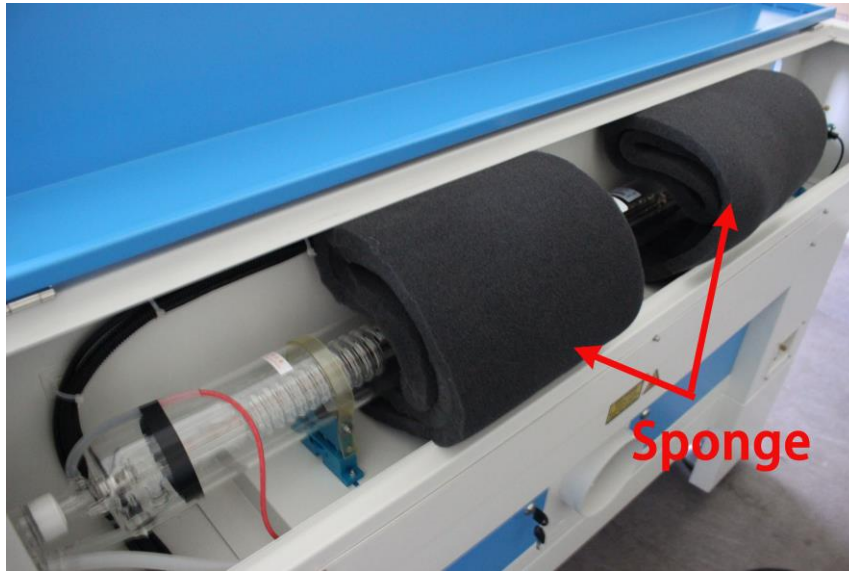

2. Take out the nylon cable ties around the honey comb plate and X axis.
Remove the transparent bag out of the first mirror mounts, the second mirror mounts, the third mirror mounts and the standard laser head. Like below:

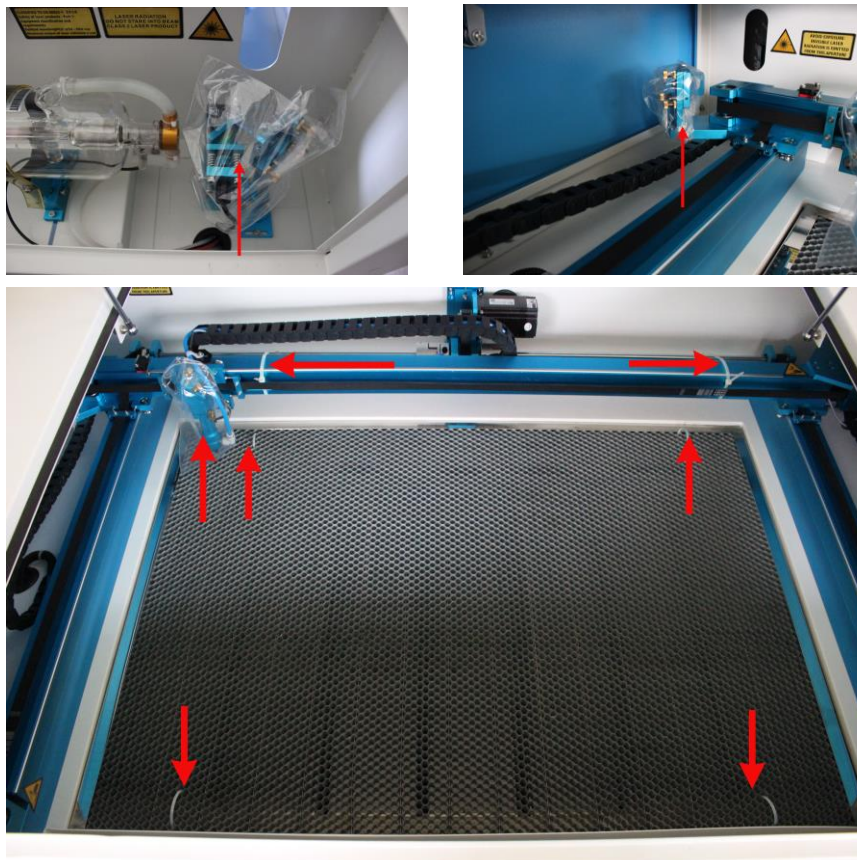

PS: The lid with a set of key and a manual focusing tool for users

3. Open the emergency switch (must do it for the first time to use the machine).

Like below



4. After carried the machine into room, please re-fix the foot of the four corners.

Please refer to below shown:



3.4 Exhaust System – Requirements

To guarantee the right ventilation during the engraving and the cutting. The device must be equipped with a fine exhaust fan (generation of rubber dust), if you use a carbon filter (neutralization of smells) will be better for exhaust effect. A good exhaust fan of the outgoing air is also required when cutting plastics or engraving wood.



Connection - see section 3.7.3 connecting the Exhaust System.



Do not start the machine without an adequate exhaust system.

3.5 Air System – Requirements

To guarantee do not catch fire and too much smoke during the engraving and the cutting. The device must be connecting with the laser to make sure the laser is safe during the work.



3.6 Computer – Requirements

The following recommendation represents the minimum requirements. When using a more powerful computer the graphics are generated and displayed faster and the computing times and the data transfer to the laser are reduced. To use the newest software version, you might have to abide other requirements.

- Windows 10 (32 bit or 64 bit)
- Windows 8 (32 bit or 64 bit)
- Windows 7 (32 bit or 64 bit)
- Windows Vista (with Service Pack 1 or later)
- Windows XP (with Service Pack 2 or later)
- 1024 MB of RAM, 400 MB of hard disk space
- Pentium® 3 or 4 processor or AMD Athlon™ XP
- 1024 x 768 or better monitor resolution
- 1 free USB interface
- 1 free Ethernet interface
- Mouse

3.7 Connections



Perform the connections exactly in the order described; otherwise electrostatic charging can damage your computer and/or the electronics of the laser system.

3.7.1 Connecting the Mains

Connect one end of the mains cable with the connection socket at the rear side of the laser device (see Figure below) and the other end with a protected power outlet.



Mains voltage and operating voltage must correspond (AC 230V 50/60 Hz or AC 115V 50/60 Hz) – see information label beside the connection socket.

Under no circumstances switch on the device if the voltages do not correspond.

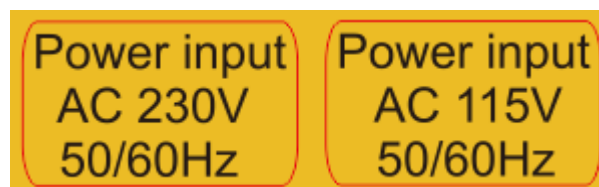

3.7.2 Connecting the Computer

Connecting the Computer and the machine by using the USB cable. Like below:



Connecting the Computer and the machine by using the Ethernet cable. Like below:



3.7.3 Connecting the Exhaust System

How to set up the exhaust system

Insert one side of the gray exhaust pipe into the fan inlet and the other side into the fuselage behind the exhaust tank. Insert one side of the gray exhaust pipe into the fan outlet and put the other side of the pipe outside where you work (If the machine is far from the outside of the room that the gas manufactured by the machine cannot be discharged; then you might need an dust/fume filter, it can keep the air quality of your working environment well).

Please refer to the following pictures about how to install the exhaust pipe:

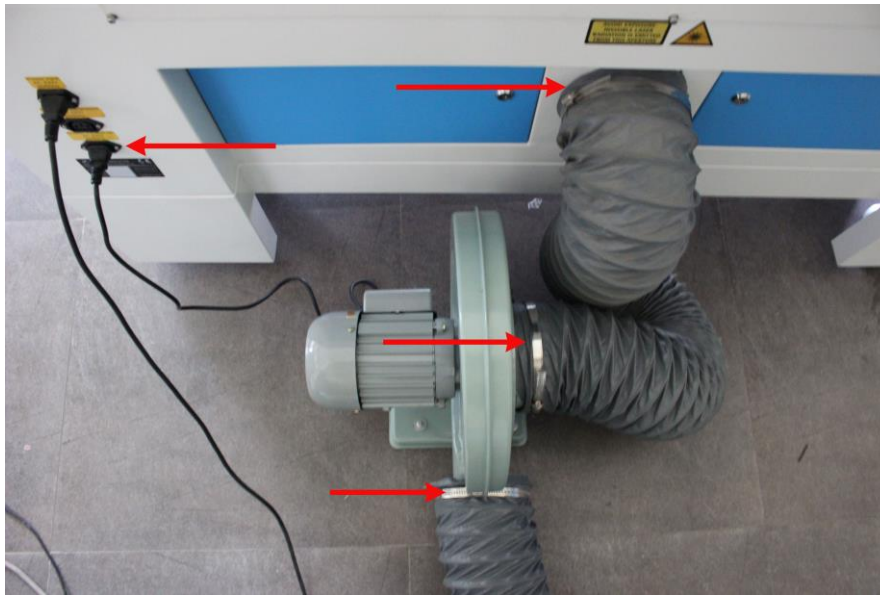

Also you can refer to the video on how to set up your Nova laser machine in our website <http://www.thunderlaser.com/how-to-use-your-laser-machine/how-to-setup-your-nova-laser-cutter.html>

The input voltage must correspond (AC 230V 50/60 Hz or AC 115V 50/60 Hz) – see information label beside the connection socket.



Output: Exhaust fan
AC 230V
50/60Hz

Output: Exhaust fan
AC 115V
50/60Hz

Tips: Do not connect the air compressor or the water chiller to the above interface, if connect them to the above interfaces that cause in failure of the machine, the warranty does not covered.



3.7.4 Connecting the Air System

First of all, Install a air blowing mouth (copper) to the air system, then connect the hoses (white side) to the mouth, the other side to the machine. After that, please connect the power cable (of the air system) to the machine. Like below:



The input voltage must correspond (AC 230V 50/60 Hz or AC 115V 50/60 Hz) – see information label beside the connection socket.



Output: Air compressor AC 230V 50/60Hz	Output: Air compressor AC 115V 50/60Hz
--	--



3.7.5 Connecting the Cooling System

If you have the water chiller, and please connect to the water chiller priority. If not, and please connect to the water pump.

The connection of the machine and the **Water chiller**.

- ① Take out one of the water pipes and connect to the water chiller where marked as “OUTLET”, the other side of the pipe connect to the machine where marked as “Water IN”.
- ② The other pipe, please connect to “INLET” of water chiller and “Water OUT” of machine.
- ③ Find the cable (in the toolbox) for “No Water” protection, please connect to “ALARM OUTLET” of water chiller and machine.



We will provide a certain chiller power cable for different countries, and the power cable will be put inside a box together with the water chiller.

The connection of the machine and the **Water pump**

- ① Take out one of the water pipes and connect to the water pump, the other side connect to the machine where marked as “Water IN”.
- ② The other pipe, please connect to the machine where marked as “Water OUT”, the other side directly into the water.

Like below:

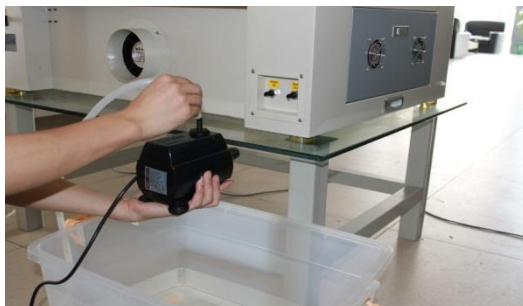

We will provide a certain pump power cable for different countries, and the power cable has been connected to the pump already before we send it out.

Get through the water chiller or the water pump, and turn on the main power.

Check the water chiller or pump to work (If normally work, the green light will light or water will flow from the pipe) .

Chapter 4 Operation

4.1 Machine View

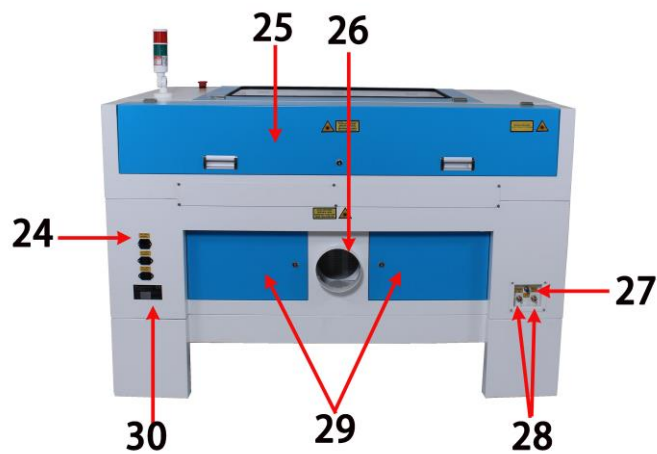
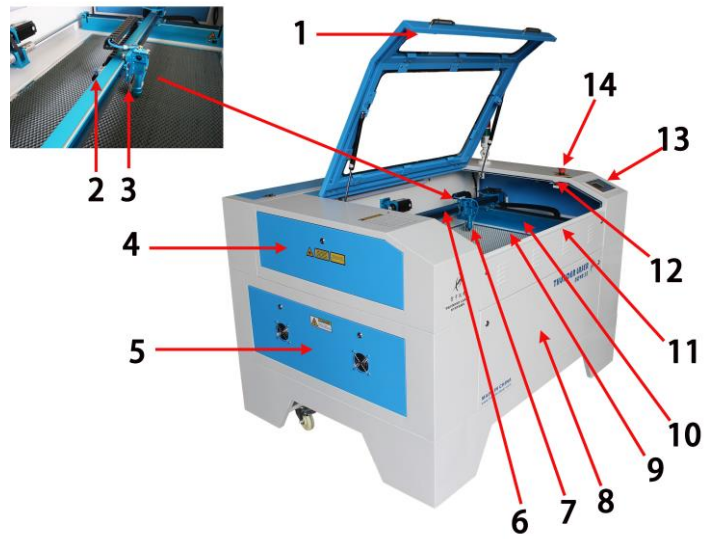



- | | |
|---------------------------------|---------------------------------|
| 1. Top lid | 16. Laser power switch |
| 2. Hand valve Pneumatic Fitting | 17. Main power switch |
| 3. Auto focus sensor | 18. Ethernet port |
| 4. Left-up side door | 19. U-disk connection port(USB) |
| 5. Left side door | 20. PC connection port(USB) |
| 6. X-axis | 21. Right side door |
| 7. Laser heads | 22. Right-up side door |
| 8. Front door | 23. Indicate light |
| 9. Honey comb table | 24. Power supply socket |
| 10. Y-axis | 25. Laser tube cover |
| 11. Front up door | 26. Exhaust hose |
| 12. Flap protection sensor | 27. Blow air port |
| 13. Control panel | 28. Water in and water out |
| 14. Emergency stop switch | 29. Rear door |
| 15. LED lamp | 30. Manufacturer's label |

1. Top lid

If the Top lid is opened, no data is processed. When the protection cover is opened during working, the motion system is stopped and the laser source is turned off. During processing of commands the protection cover must only be opened after pressing the "Pause "button.

2. Hand valve Pneumatic Fitting

It's used for adjust that blow air amount.

3. Auto focus sensor

Used for the automatic focusing of the work table.

4. Left-up side door

Open this door for cleaning the second reflective mirror or align that laser beam

5. Left side door

There is laser power supplier, Ammeter, TL-Timer etc. please open this door for checking these parts, but must pay attention to the electric current.

6. X-axis

The motion system is that performs the mechanical movements in X direction. The X-axis is visible in the working area.

7. Laser head

Laser beam and red dot pointer are all come out from the laser head, and the Auto Focus switch is installed on the laser head, too. The bottom of laser head is parallel to the bottom of the autofocus switch.

8. Front door

Open this door for cleaning the waste after working.

This door is locked by using two outside locks.

9. Honey comb table

The honey comb plate to be processed is put onto the working table. Put the material on the working table for engraving & cutting

10. Y-axis

The motion system is that performs the mechanical movements in Y direction. The Y-axis is visible in the working area.

11. Front up door

Open this door for take out the honey comb table and it's convenient to put that material on working table

This door is locked by using inside screws and outside locks.

12. Flap protection sensor

This is where Open flat protection exist. Laser will stop working once the cover is opened during working.

13. Control panel

You can control the X-axis, Y-axis and Z-axis manually by the display panel, it also shows the working time, power, speed and the whole working time and affords many function options(please view this chapter 4.3 for detail).

14. Emergency stop switch

Once there's an accident happen (laser catch fire, laser out leakage) during working, please turn off this switch immediately. It will be cut off the laser power and motion power immediately.

15. LED lamp

It's used for lighting the working table once turn the Main switch on.

16. Laser power switch

The laser power will be on while you turn it on

17. Main power switch

The laser machine will be start while you turn it on

18. Ethernet port

This Ethernet port is for connecting computer.

19. U-disk connection port(USB)

You can save the file as a U-disk File by press "SaveToUFile" on the software, then save it to the u-disk and insert the u-disk to the port of laser machine, then use the control panel to select and control it to work

20. PC connection port(USB)

This USB is for connecting computer.

21. Right side door

There are laser controller, driver(Hybrid Servo Drive and Micro Stepper Drive), power supplier (both 24v DC and 36vDC), the main connecting cables and cooling fan here, please open this door for checking these parts, but must pay attention to the electric current. if you need to repair, please contact with professional maintenance staff.

22. Right-up side door

Maintenance for the Emergency stop button if required
This door is locked by using outside locks.

23. Indicate light

The light is always keeping green color while the laser does not work or working but the lid is closed.

The light will turns to red color while the lid/cover is opened during working.

24. Laser supply socket

To connect the main power and the extend power according the label information. And in the main power socket have the fuses.

25. Laser tube cover

There are installed the laser tube, red dot pointer device, beam combiner and the first reflective mirror mount.

26. Exhaust hose

This is for installing the exhaust device.

27. Blow air port

This port is for connecting hoses of the air compressor.

28. Water in and water out

Both ports are for connection with water pump or water chiller.

29. Rear door

There are installed cables banks etc. please open this door for checking these parts, but must pay attention to that electric current.

30. Manufacture's Label

It's Show you the laser information like serial number or manufacturing date etc.

4.1 ON/OFF Switch

The mains and the laser supply power ON/OFF switch

The following conditions must be fulfilled for correct start up:

Unrestricted freedom of motion of the mechanics

No materials under the engraving table

Protection covers closed

When turn on the power of machine, and note that turn on the main switch first and then the laser supply power switch

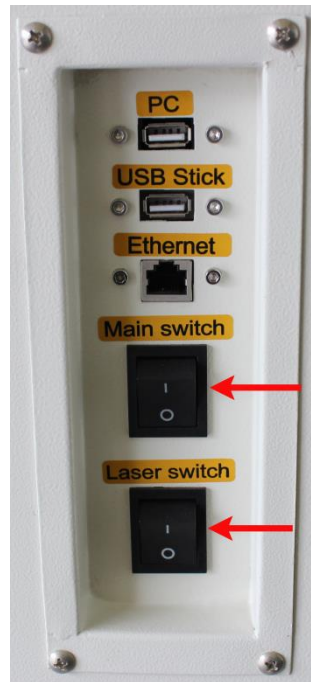

If all covers are closed, immediately after being switched on, the device starts the referencing process. When the referencing process is completed correctly, an acoustic signal sounds and the device is ready for operation. The operation panel will display the home screen when the laser is completed resets.



Before switching on the device, the user must make sure that no objects of any kind are located inside the operating space, which could limit or obstruct the mechanics of the device.

4.3 How to use the TL-Timer

The TL-Timer is an additional tool for laser machines.

It will control laser machines periphery like exhaust fan, warning lights, electrical locks and lost of other stuff automatically.

This will increase the ease of use of your laser machine.

Please note the different types of connection, which makes the TL-Timer able to work with each kind of laser controller.

Operation:

Normal use:

The TL-Timer gets activated by a work status signal from laser controller and an open/close signal from the lid.

When the laser is working with the lid is closed, the second red LED and third red LED lights up and 2 relays will be activated until the signal from controller gets turned off.

Without control signal the 2 relays will stay turned on until a given delay time has expired.

When the laser is working with the lid is opened, the first red LED light will be on and the relay will be activated until you closed the lid.

Each relay has a freely adjustable delay time from 0-99 seconds.

Set up delay time:

Enter "Set" switch once. The red LED will blink and the display will show you the delay time in second for the first relay. A red LED close to the active relay will show you. Which one is active?

The display does show the delay time in seconds. By pressing "down" or "up" you can change the value. By holding a switch down for more than 1 second the value will increase or decrease automatically.

By pressing "Set" you can switch to relay number 2 now and confirm the delay time for this one.

For changing delay values for 3rd and 4th relay you have to press "Set" again.

When 4th relay is active and you press "Set" again, the TL-Timer will turn back to normal operating mode, the red LED will stop blinking, but the blue LED will be still keeping on

After turning of power the TL-Timer will remember the delay-time-values, you did enter before.

Relay-Output:

Each of the 4 relays offers an opening and closing switch with current capacity of max.

8 Amps and a power capacity of max. 1000W.

Higher loads must be controlled by using a power contactor.

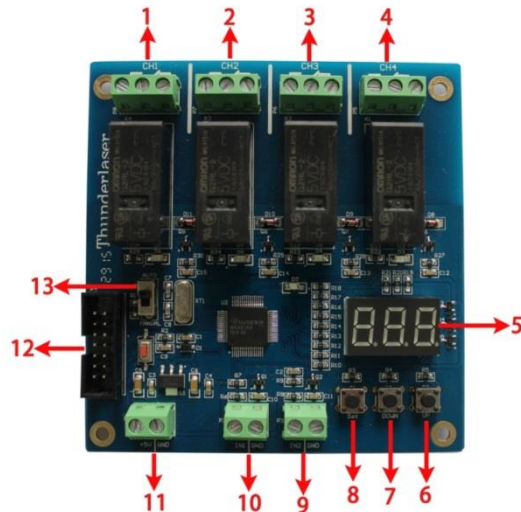
About TL-Timer controller interface and buttons description:

- 1: Interface 1, connection with warning light , delay time is set to 0 second (Factory default settings, change it if required)
- 2: Interface 2, spare interface, users can connect the relevant equipment if required
- 3: Interface 3, connection with exhaust fan, delay time is set to 15 second (Factory default settings, change it if required)
- 4: Interface 4, spare interface, users can connect the relevant equipment if required
- 5: LED lights display, set the delay time for viewing each interface and enter
- 6: "UP" button to increase delay time
- 7: "DOWN" button to reduce delay time
- 8: "Set" button to confirm your setting
- 9: Interface 9, " lid state" interface
- 10: Interface 10, "Working state" interface
- 11: Interface 11, 5V DC voltage power interface
- 12: upgrade interface
- 13: auto and manual

Where the TL-Timer is installed with Thunder Laser machine, please refer to the pictures as below (Backside of machine) :



In addition: The on/off of air pump is controlled by the layer of software, like below:

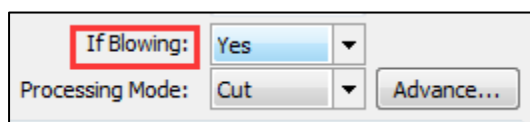

4.4 How to replace the 4 inch and HR laser head

1) How to replace the 4 inch laser head

1. Move the table down till there's enough space to take the standard head out and install the 4" laser head.

2. Remove the standard head like below:

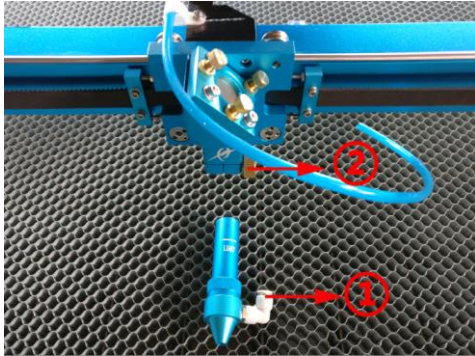

①take out the air hose

②loosen the screw

3. Install the 4" laser head like below:

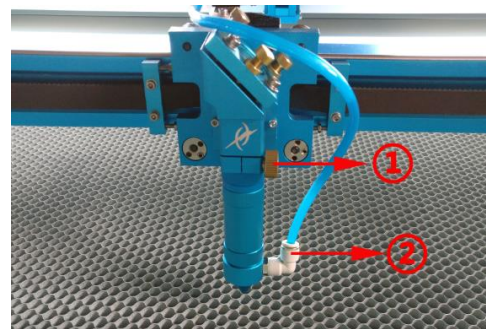
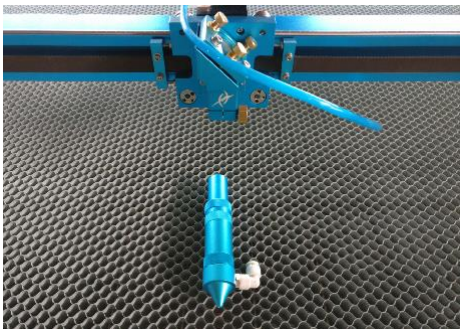

①fix the laser head

②connect the air hose

Tips: Please keep the 4" laser head to the max height of laser head.



2) How to replace the HR laser head

1. Move the table down till there's enough space to take the standard head out and install the HR head.
2. Install HR head, like below:

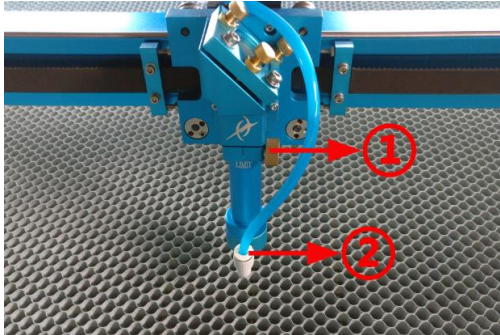

- ①fix the head
- ②connect the air hose

Tips: Since HR head is sensitive for focus distance, it's suggested to adjust the focus by manual rather than auto focus.

4.5 How to adjust focus distance by manual or auto

1). If there's no auto focus function for your machine or there's fault for your auto focus, you can refer to below instructions about how to adjust focus **by manually**:

1. For standard laser head:

find the 6mm Acrylic Focus Tool for help to adjust the focus directly like below:

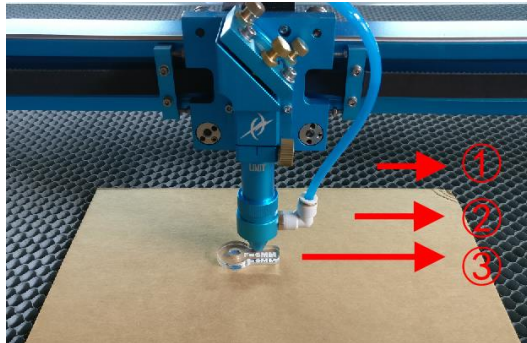

- ① Working Table
- ② Material
- ③ Focus Tool

If the focus tool is not the best one for your material, you can use the focus ruler for help like below:

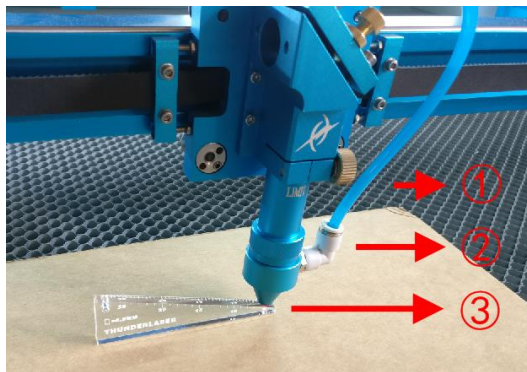

- ① Working Table
- ② Material
- ③ Focus Ruler

Please note that the limit line of the head, this limit line indicates the max height of laser head, and keep the limited line inside the laser head mount. So as to protect the laser head from crashing into the honey comb table while z-axis does reset/auto focus

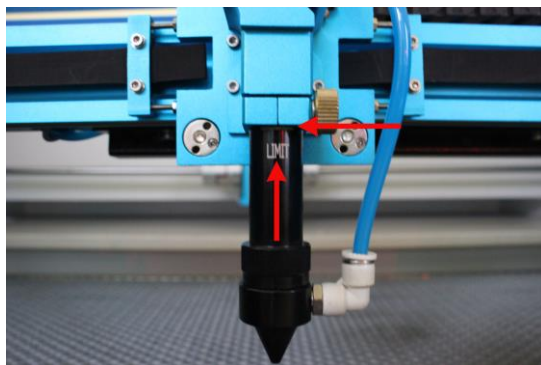

2. For HR laser head

Since HR head is very sensitive for focus distance, thus we've tested and made a special focus tool (with a best distance) for each HR head, like below:

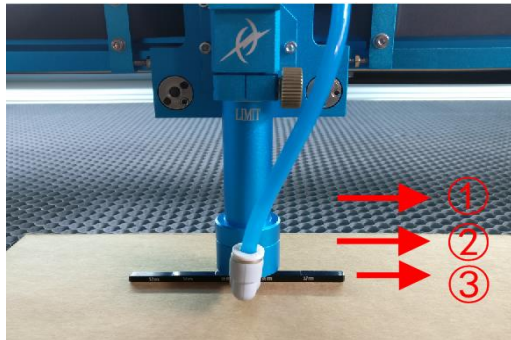

- ① Working Table
- ② Material
- ③ The Best Focus Distance
- ④ Focus Tool

Please note that the limit line of the head, this limit line indicates the max height of laser head, and keep the limited line inside the laser head mount. So as to protect the laser head from crashing into the honey comb table while z-axis does reset/auto focus

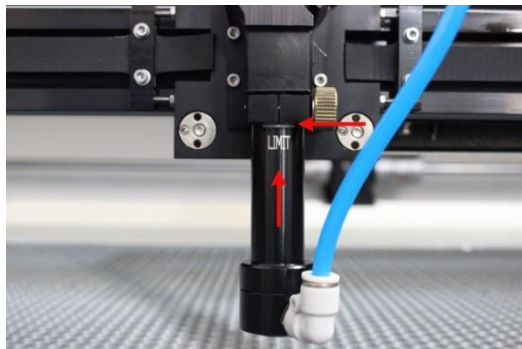

3. For 4" laser head

4" laser head is not so sensitive for focus distance; you can set the distance about 10mm with the help of focus ruler

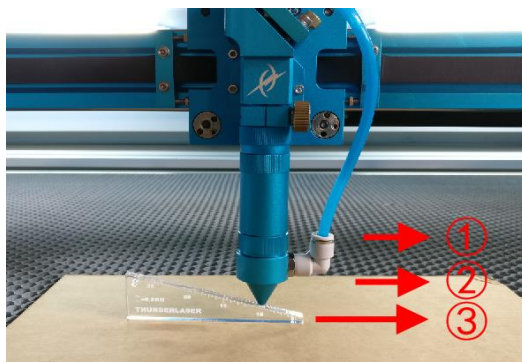

- ① Working Table
- ② Material
- ③ Focus Rule

PS: Please keep the 4" laser head to the max height of laser head

2) If there's Auto Focus function for your machine like below, you can adjust the focus by auto.

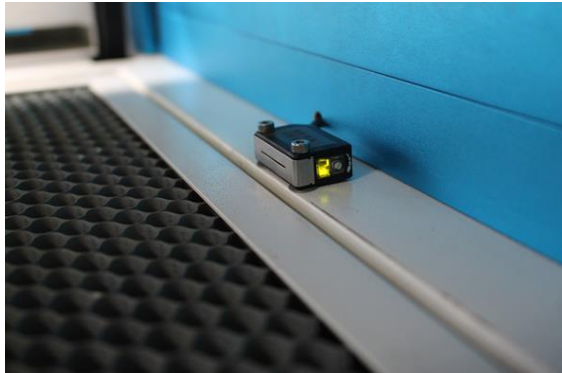

1. Reset Z-axis.(Z-axis will move up until touch the Auto focus switch, here the coordinate: 0,0) please refer to Pic 1.
2. Select “Auto focus” on display panel, then the table will auto focus directly, please refer to pic 2.

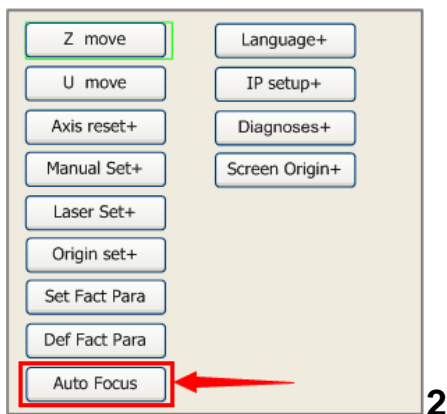
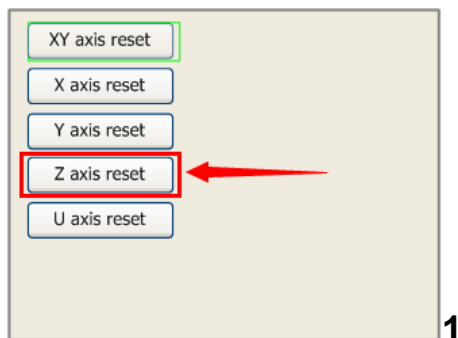

PS: please do not use “auto focus” function while laser head is HR laser head or 4” laser head.

Also you can refer to the video of how to use auto focus in our website:

<http://www.thunderlaser.com/how-to-use-your-laser-machine/how-to-use-auto-focus.html>

4.6 How to use the display

4.6.1 Function of the Buttons

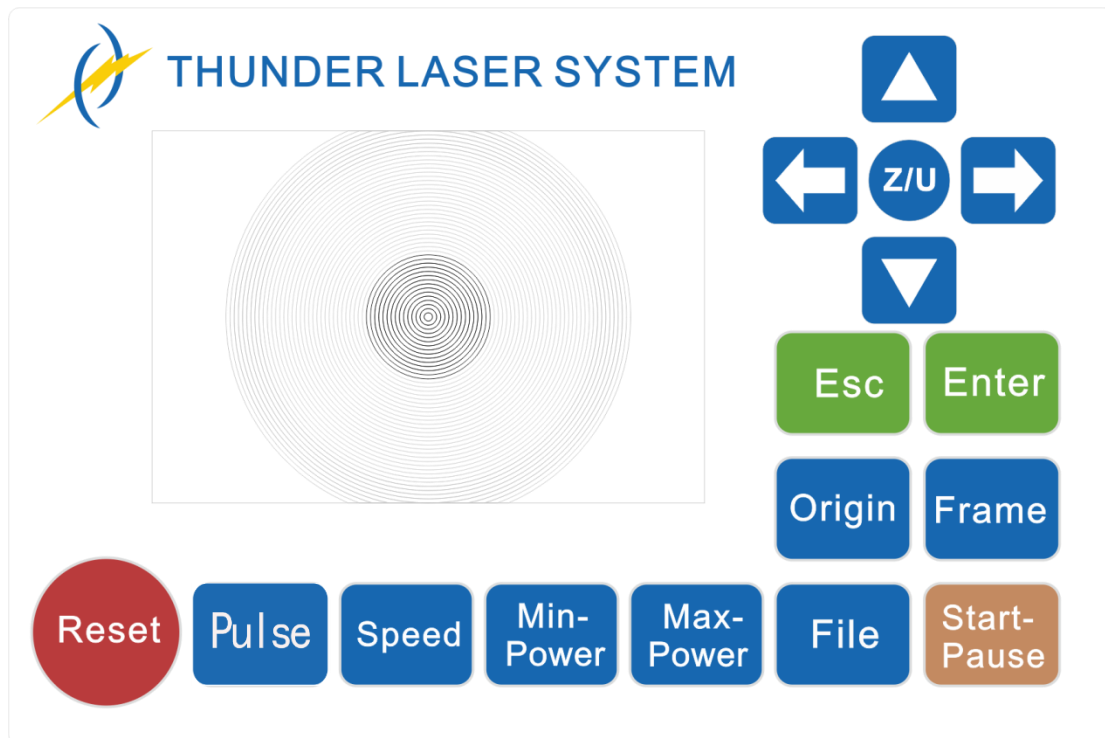



✧  Arrow buttons: control the movement of the laser head.(also can be used to change the parameters in the control panel)

✧  Z/U button: The Z/U key can be pressed when the system is idle or the work is finished. On pressing this key, it will show some entries in the interface, each entry includes some functions, Z axes move, U axes move, each axes to go home etc.







✧  Reset button: reset the machine.

✧  Pulse button: single press to draw a dot, press and hold to drill a hole.

✧  Speed button: Set the speed of the current running layer, or set the direction keys' move speed.

✧  Min-Power button: Set the min laser power of the current running layer.



- ✧  Max-Power button: Set the max laser power of the current running layer, or set the power of “Laser” Key.
- ✧  File button: The management of the memory and U disc files.
- ✧  Start-Pause button: run/pause the current job.
- ✧  Origin button: set the starting point for the laser head.
- ✧  Frame button: To track by the current file’s frame.
- ✧  Esc button: To stop work, or return to the last menu.
- ✧  Enter button: confirm your selection.

4.6.2 The main interface

When the system is powered on, the screen will show as below:

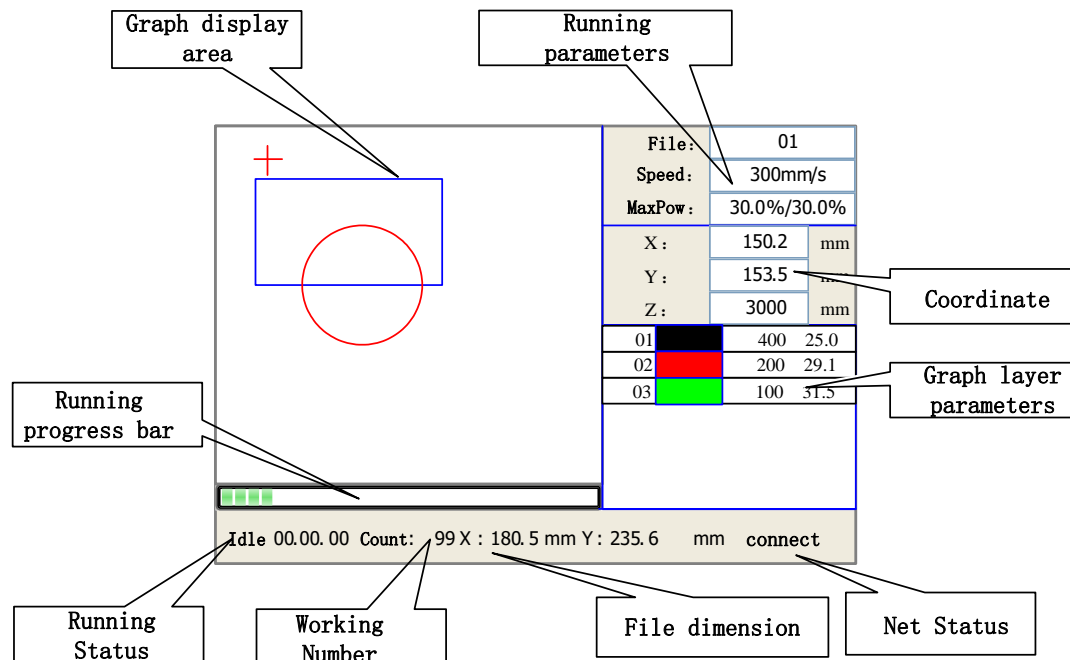

- Graph Display Area: To display the whole file's track, and display the running track.
- Running parameters: To display the running file's file number, speed, max power etc.;
- Coordinate: To display the current coordinate of X,Y and Z axes
- Graph layer parameters: To display the layers' information of the current file, such as max or min power, speed etc.. When system is idle, dblclick the layer, then users can change the layer's parameters and the changing would be saved.
- Running Status: To display the current status of the machine, such as Idle, Run, Pause, Finish, etc.;
- Running Progress Bar: To display the progress bar of the current running file;
- Working Number: To accumulate the work number of the current file.
- File Dimension: To display the dimension of the current file;
- Net status: To display the connecting status of the Ethernet.

When work is Idle or finished, all keys can be pushed, users can select a file to run, set some parameters, preview to a select file etc. But, when work is running or paused, some keys don't respond when they are pushed.



4.6.3 Speed Key

Push the “Speed” key when the screen is on the main interface, it will show as below:

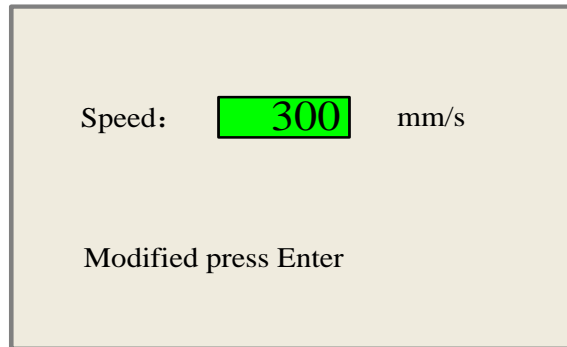

Push the “X+/-” Keys to move the cursor in the numeral area, and push the “Y+/-” keys to change the value, then push the “Enter” key to save the change, push the “Esc” key to invalidate the change.

4.6.4 Max/Min Power Keys

Push the “Max Power” or the “Min Power” keys when the screen is on the main interface, it will show as below:

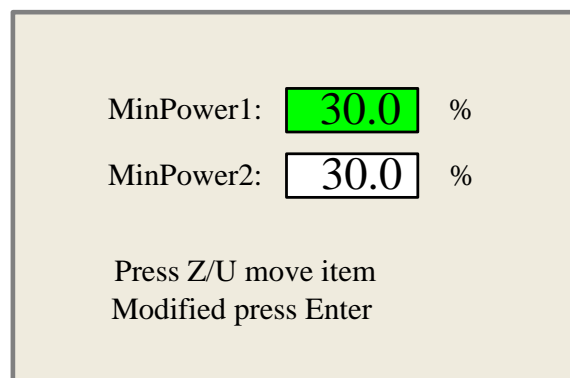
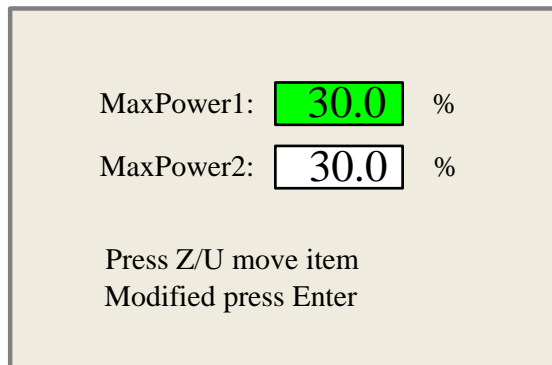



When “Z/U” key is pushed, the green block can move up and down to denote the changing item, then “Y+/-” keys and “X+/-” keys can be used to change the value.



4.6.5 Set the Layer Parameters

After selecting a file to preview on the main interface, user can push “Enter” key to let the cursor move to the first layer, then “Y+/-” Keys can be pushed to select the intent layer, on that time, user can push “Enter” key to check the selected layer’s parameters, show as below:

01		400	25.1
02		200	29.1
03		100	31.5

Layer0:

Speed: mm/s

MinPower1: %

MinPower2: %

MaxPower1: %

MaxPower2: %

Press Z/U move item
Modified press Enter

User can push “Z/U” Keys to move the green block on the intent parameter, then he could change the parameter if needed. “OK” to validate the change, and “Esc” to invalidate the change.

4.6.6 Z/U Key

The Z/U key can be pressed when the system is idle or the work is finished. On pressing this key, it will show some entries in the following interface:

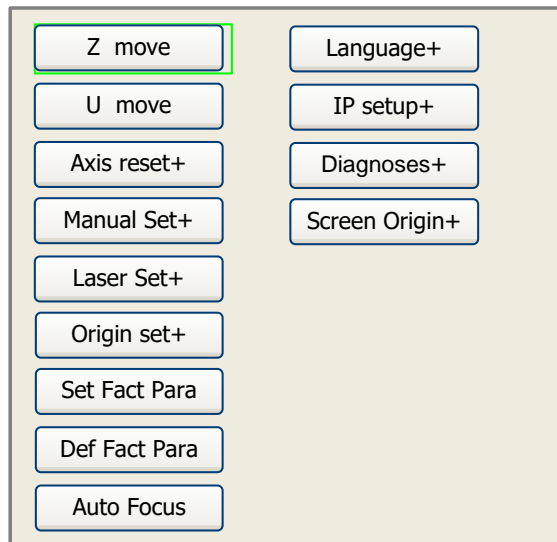

Press up and down arrow keys to move the green block to the anticipated item, and then push the “Enter” key to display the sub menu.

4.6.7 Z Move

When the green block is on “Z Move” item, to move the Z-axis table up and down by press left and right arrow keys, then press ESC to go back to normal x & Y axis control.

4.6.8 U Move

When the green block is on “U Move” item, to move the Z-axis table up and down by press left and right arrow keys,

4.6.9 Axis Reset+

When the green block is on this item, push the “Enter” key to show as below:

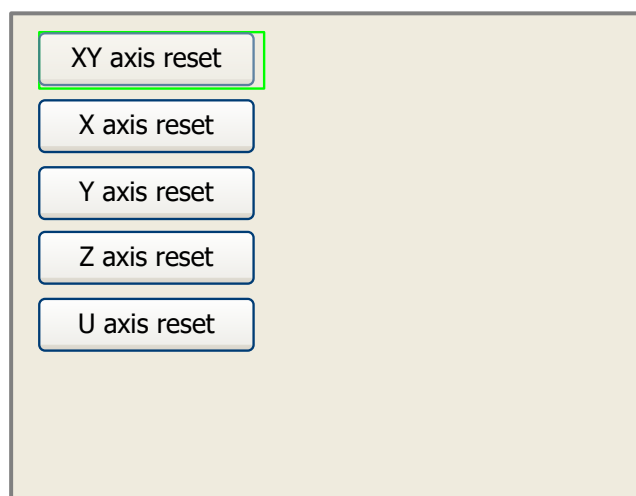

Press up and down arrow keys to move the cursor to one of the entry, then push “Enter” key to restart the selected axis, the screen will show some information when resetting.



4.6.10 Manual Set+

When the green block is on this item, push the “Enter” key to show as below:

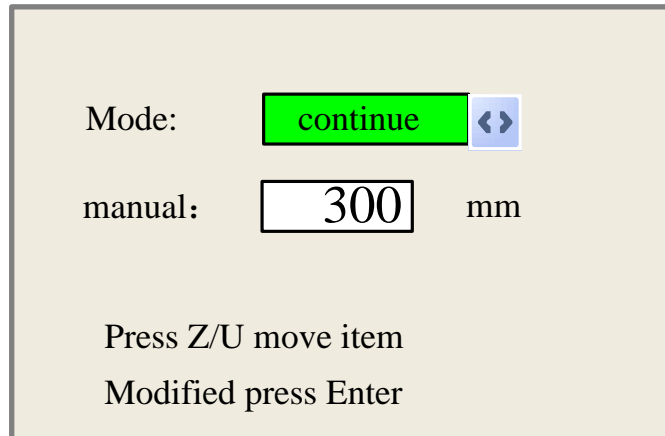

Push “Z/U” key to move the green block, and when the green block is on the “Mode” item, push “X+/-” keys to select the anticipated value, “Continue” or “Manual”. When “Continue” item is selected, then the “Manual” item is not valid, on that time, push the direction keys to move the corresponding axes, and when the pushed key is loosed, then the corresponding axes will finish moving. When the Mode item is “manual”, then pushing the direction key one time, the corresponding axes will move a fixed length, unless the scope is overstepped.

4.6.11 Laser Set+

When the green block is on this item, push the “Enter” key to show as below:

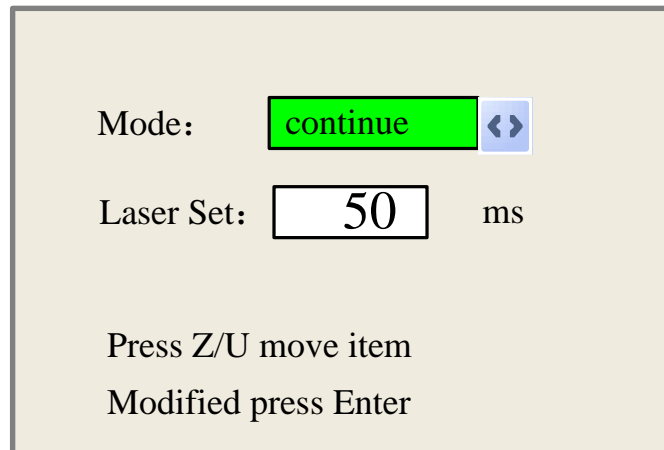

Push “Z/U” key to move the green block, and when the green block is on the “Mode” item, push “X+/-” keys to select the anticipated value, “Continue” or “Manual”. When “Continue” item is selected, then the “Laser Set” item is not valid, on that time, push the Laser key to splash the enabled lasers, and when Laser key is loosed, then the lasers will finish splashing. When the Mode item is “manual”, then pushing the Laser key one time, the enabled lasers will splash a fixed time.

**4.6.12 Origin Set**

When the green block is on this item, push the “Enter” key to show as below:

Muti origin enable
 Origin enable1 Origin enable3
 Origin enable2 Origin enable4

Set origin:

Next origin:

Press Z/U move item
Modified press Enter

Push “Z/U” key to move the green block to the anticipant item, and when the green block is on “enable” items, push “Enter” key to enable or disable the item, when enabled, the small diamonds is green, and when disabled, the small diamonds is grey. When the green block is on the “Set origin” item or the “Next origin” item, push the “X+” keys to select the value.

Pay attention to if when the green block is on the “Set origin” item, push the “X+” keys to select a value, then, “Enter” key must be pushed to valid the change, or, the change is invalid.

Each item introduced as below:

- Multiple Origins Enable: “Yes” or “No” can be selected. If you select “No”, the system will use the single-origin logic. You can press the “Origin” key and set the origin, and only this origin can become valid. If you select “Yes”, the system will use the multiple- origin logic and the “Origin” key on the keyboard become invalid. In such a case, the parameter of each origin must be set in the menu as follows.
- Origin Enable1/2/3/4: after the multiple-origin logic is enabled, the four origins can independently be prohibited and enabled.
- Set Origin 1/2/3/4: after the multiple- origin logic is enabled, you can stop the cursor at “Set as Origin 1/2/3/4”. Press the “Enter” key on the keyboard and the system will take the coordinate figures of current X/Y axles as the corresponding ones to the origin 1/2/3/4.
- Next Origin: there are such five digits as 0~4 for option, which are the origins to be used for the next figure. Origin 0 means the origin set by the “Origin” key on the panel in the single- origin logic. 1~4 means the serial number of the origins in the multiple- origin logic. Next origin can be modified to any one of origin 1~4, so as to control the start location of next work (the premise is that the origin is enabled), but it can’t be modified to origin 0.



 <p>Prompt</p>	<p>Once the multiple- origin logic is selected and if the serial number of the next origin is 1 and four origins are enabled, when the memory file function is started or the processing file is uploaded into the PC and this file selects "Take the Original Origin as current Origin", the work started for each time will use different origins. The rotation order of origin is 1->2->3->4->1->2.....</p>
---	---

4.6.13 Set Fact Parameters

After the "Set Fact Para" is selected and the Enter key pressed, the interface will show the specific password to be entered when set as default parameter.

Password:

Password error

0 1 2 3 4 5 6 7 8 9
 A B C D E F G H I J
 K L M N O P Q R S T
 U V W X Y Z

Push "X+/-" keys and "Y+/-" keys to select the characters, and push the "Enter" key to valid the characters, when finishing enter the password ,that is to say, the six characters, if the password is error, it prompts there is some error, or, all parameters are stored.

 <p>Prompt</p>	<p>After the manufacturer regulates all parameters of the machine well (including all manufacturer parameters and user parameters), this function can be used to store the well-regulated parameters to help users to recover the original parameters (including all manufacturer parameters and user parameters) through selecting "Recover Para" when they regulate parameters improperly.</p>
---	--

4.6.14 Def. Fact Parameters

After the "Def Fact Para" is selected and the Enter key pressed, the "Successful Recovery" dialog box will pop up to prompt that all manufacturer parameters and user parameters are recovered successfully. You can return to the previous menu by press the Enter key.

4.6.15 Auto Focus

When the cursor stops at "Auto Focus", press the Enter key to search for the focus(When there is z axes, and the z axes reset function is enabled, the auto focusing is valid); press the Esc key to return the prior menu.

4.6.16 Language

The item "Language" helps you to select a appropriate langue which is displayed on the pane:



4.6.17 IP Setup

When the green block is on this item, push the “Enter” key to show as below:

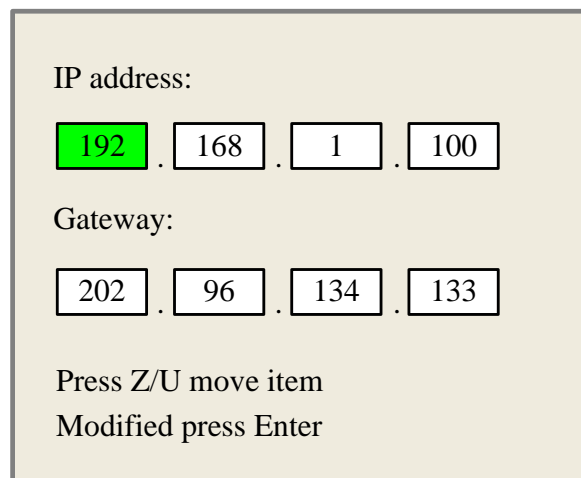

IP address:

192 . 168 . 1 . 100

Gateway:

202 . 96 . 134 . 133

Press Z/U move item
Modified press Enter

Push “Z/U” key to move the changing item, then push “X+/-” keys and “Y+/-” keys to change the value, when all the IP value and the Gateway value are changed, push “Enter” key to validate the change, or “Esc” key to invalidate the change.

4.6.18 Diagnoses

If the “Diagnoses” item is pressed, the system will show as below:

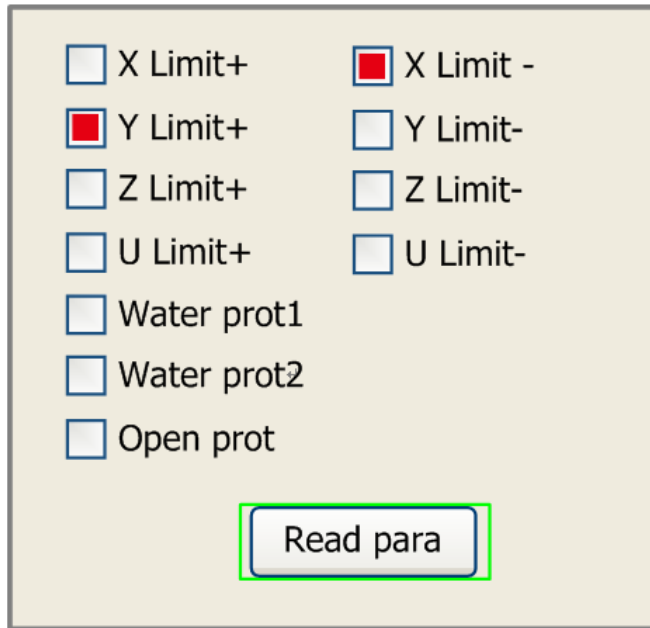

This interface shows some system input information, such as limiter status, the status of the water protecting, and the status of the foot switch etc.. When the input is validated, the color frame will be red, otherwise it's gray.

4.6.19 Screen Origin

If the "Screen Origin" item is pressed, the system will show as below:

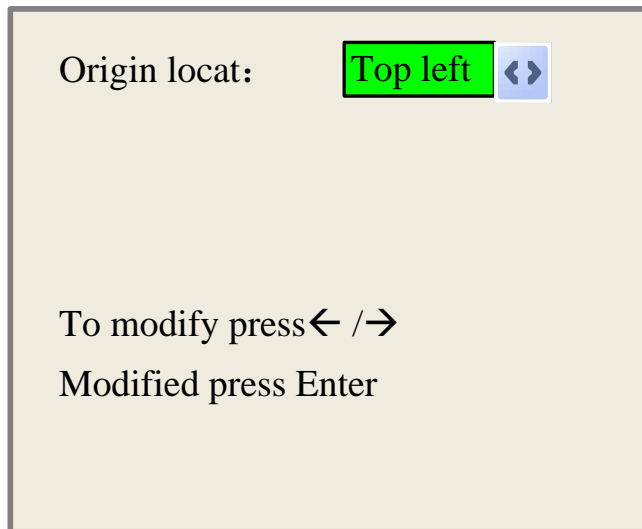

There are four entries to be selected: Top Left, Top Right, Bottom Left and Bottom Right. When one is selected, the previewed graph on the screen would be enantiomorphous based on X or Y direction.

 Caution	<p>This item is only used to preview the file on the screen, and it is no meaning to the machine's movement.</p>
---	--

4.6.20 File Key
1). Memory File

On the main interface, if “File” key is pressed, it will show as below:

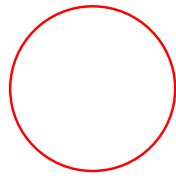
File:	Count:	Read mem file	File:	01	
01	400	Udisk+	Speed:	300mm/s	
02	200	Other+	MaxPow:	30.0%/30.0%	
03	100	Run	X:	150.2	mm
		Track	Y:	153.5	mm
		Work time	Z:	3000	mm
		Clear count			
		Delete			
		Copy to udisk			
Idle 00.00.00 Count: 99			X: 180.5 mm	Y: 235.6 mm	connect

When showing this menu, the system would read the memory file firstly, the file name and the work times would be listed in the area, and the selected file is previewed in the bottom right area. “Y+/-” keys could be used to move the cursor on the file name list. When the cursor is on a target file name, presses the “Enter” key, the selected file will be previewed on the main interface, and then if “Esc” key is pushed, the preview will disappear.

“X+/-” keys could be used to move the cursor left and right. All the item show as below:

- **Read mem file:** read the memory file list;
- **Udisk:** read the U disk file list;
- **Other:** the other operation of the memory files;
- **Run:** To run the selected file;
- **Track:** To track the selected file, and the track mode is optional;
- **Work time:** To forecast the running time of the selected file, and the time is accurate to 1ms;
- **Clear count:** To clear the running times of the selected file;
- **Delete:** To delete the selected file in the memory;
- **Copy to Udisk:** To copy the selected file to Udisk;

If the “Other” entry is pressed, the system will show as below:

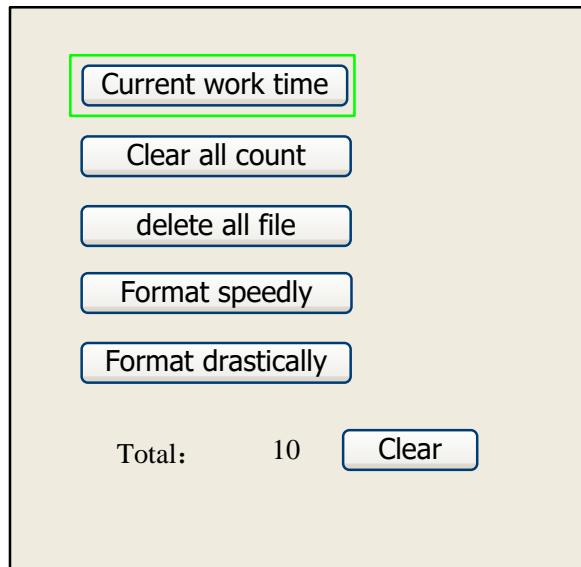

- **Current work time:** To forecast the running time of the current file(the current file No. is showed on the main interface), and the time is accurate to 1ms.
- **Clear all count:** To clear the running times of every file in the memory
- **Delete all file:** To delete all memory files
- **Format speedily:** To format memory speedily, and then all the files in memory will be deleted.
- **Format drastically:** To format memory drastically, and then all the files in memory will be deleted.

Total: the total running times of all the files.

2). U-Disk File

If the “U-disk” entry in figure 8.4-1 is pressed, the system will show as figure 8.4-3, and the operation method is all the same as figure 8.4-1.

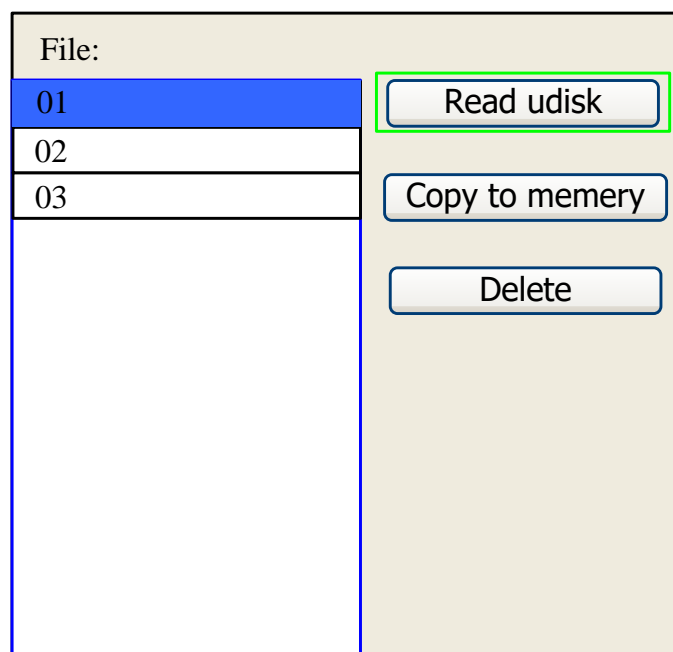

- **Read Udisk:** read the file list in the Udisk;
- **Copy to memory:** copy the target Udisk file to the memory;
- **Delete:** delete the selected Udisk file;

 Prompt	This system supports such file formats of Udisk as FAT32 and FAT16, but it can identify them when the files are put under the root directory of Udisk. The file name of more than 8 characters will automatically be cut out by the system. The file name that has only English letters and digits will not show when they are copied to the mainboard. The files copied from the mainboard to Udisk will be placed under the root directory of Udisk.
---	--

4.6.21 Alarm Information of Display

When users are operating the system, or when the machine is running, some alarm information such as water protecting error maybe shows as below:

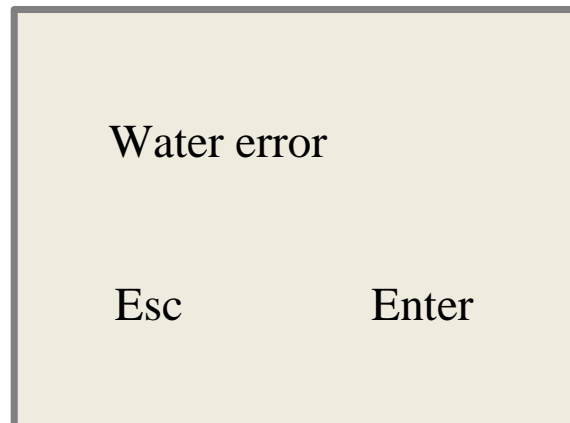

Push "Enter" key or "Esc" key, the system will execute some relative steps.

4.7 The First Time Running the Laser



1. Using the machine for the first time, and please note that the machine working voltage of 230V (115V for USA).
2. Please put the honeycomb on the standard table. Unless you need to cut on the Aluminum blade platform.
3. Move up the laser head, ensure the limit line of head tube is cover inside the holder.so as to protect the laser head from crashing into the honey comb table while z-axis does reset/auto focus.
4. Please reset Z-axis after turn on the laser machine (watch the guiding video to learn how to reset the Z-axis, and refer to the thunder laser operation video).
5. Please don't use the autofocus function if there's no materials on the table.

For example, first engraving tests

The following steps describe how to successfully engrave a first pattern. Please follow the individual steps:

1. First switch on the computer and the Laser.

Tips: When turn on the power of machine, and note that turn on the Main switch first and then the Laser switch.

2. Put the object to be engraved into the laser and move into the desired position on the engraving table. Usually the object is positioned in the upper left-hand corner. Use the rulers to determine the dimensions of the object to be engraved.
3. With the frame keys to ensure that the laser head is positioned over the material to be engraved. You focus with the help of the focus tool or by auto focus.
4. Generate a graphic with the help of your graphics software, or lead in a picture that you want to engrave, but before this, you must click the "Port setting" in the software. The size of the graphic does not matter as the printer driver adjusts it to the work piece automatically if requested.

If you have any questions, and also consult the Software Manual for further information.

5. Double-click the Layer in the window of "Work", then you can modify the parameters such as speed, Min Power, Max Power, ramp Effect, Ramp Length, Interval and so on.
6. Select "Download", you can change the file name. If you don't change the file name, that will be the default name for "default", and will be covered the last file.
7. Click "Original" and "Frame" on the display, please make sure that the material is in the right location and there is enough space for working.

8. Please check the water cooling system is working properly; the water is running into and filling the laser tube. Please do not start your work if the laser tube isn't full of water, because that may led to laser tube damage due to the high temperature.
9. Finally press the "Start-Pause" button in the display, to start the engraving process.
10. While the laser is engraving, you can generate the next graphic.
11. When the engraving is complete, the laser machine will give out the notification sound and the laser head will go back to the original point, and the warning light will return to the green light, then you can repeat engraving.

4.8 Workstation Area Indication

Side view



**workstation
area
occupied
by
operators**

Plan view



**Workstation area occupied
by operators**

4.9 Rotary axis Attachment

The rotary axis attachment option in the printer driver is used in combination of the rotary axis attachment, to engrave cylindrical objects. To compensate for the different diameters of different objects, the image must be adjusted. This is performed automatically by the engraving driver, by selecting the rotary axis option and entering the diameter of the object to be engraved.

The Rotary size:

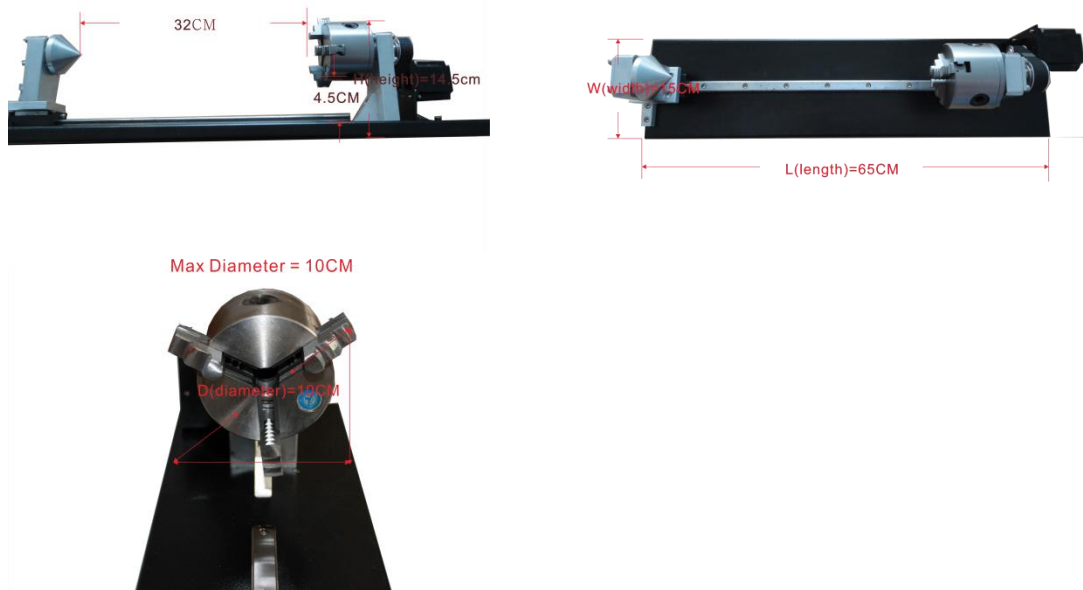

To install and set-up the rotary axis attachment proceed as described as follows:

1. Move the working table to the lower position switch off the laser and open the top lid.
2. Put the rotary axis attachment onto the working table and align the rotary attachment with the x-axis are parallel, with the jaw chuck closest to where the rotary attachment plugs in and is switched on / off
3. Connect the rotary axis attachment via the control cable with the connector of the motion system. The connector is located inside the right front of the laser. Connected it to this interface and fixed, **then turn on the switch (- is on) and reset the rotary device by press the "reset" button on the display (1 is on, 0 is off)**, and then you have finished the device connection. Like below:

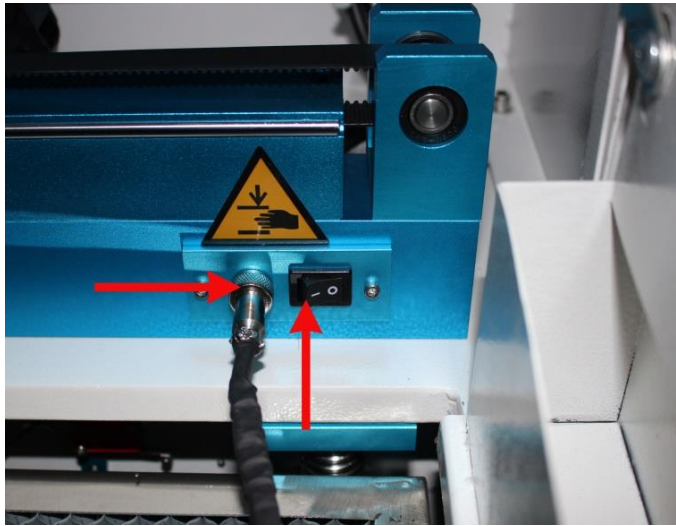

4. Before you mount the object into the rotary axis attachment, measure the diameter of the object at the position to be engraved with a sliding caliper or a similar tool. Write down this value. For example:80
5. Adjust and fix the slider to make the work piece fitting into the rotary axis attachment.
6. Once the rotary is plugged in and switched on the y axis, y-axis will be inoperable by jog control and will have to be gently moved by hand in and out of position above the rotary axis attachment. Any reset of the controller or repowering of the machine will start the homing function. The x-axis will head off to towards its limit switch and y-axis now controlling the rotary will just spin for while before timing out and setting a zero point. Be very aware
Set your focus manually, carefully and safely. It is not recommended to use the auto focus with a rotary axis attachment for the simple reason that you are not working with a flat object. Set your origin
7. Generate a graphic with the help of the graphics software. The graphics size must be adjusted until less than the dimensions of the work piece.
8. Select "Output", and then input the diameter of the object and the circle pulse. Like below:

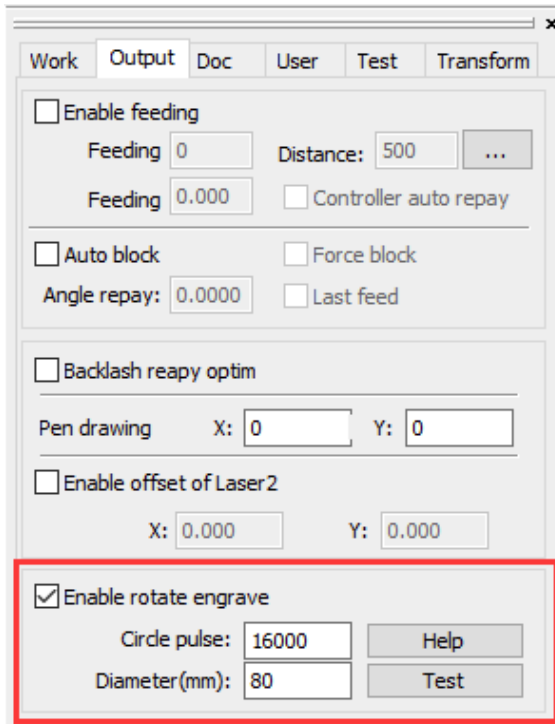

Select “Output” , and then tick “Enable rotate engrave”

- ① The Circle pulse is set to 16000 (Please set circle pulse to 7601 while your machine is bought before February 2016, Not including Feb 2016)
- ② The diameter of the target item

9. Select "Download", click “Origin” and “Frame” on the display, please make sure that the material is in the right location and enough space for working.

10. Switch on the cooling system. And connect the exhaust system and the air pump to behind of the laser. Please check the water cooling system is working properly; the water is running into and filling the laser tube. Please do not starts your work if laser tube isn’t full of water, because that may led to laser tube damage due to the high temperature.

11. Finally press the “Start-Pause” button in the display, to start the engraving or cutting process.

12. When you are finished with the rotary attachment:

Move the y-axis back by hand before switching the rotary off (0 is off) and unplugging it to give yourself plenty of room to remove it safely.

Uncheck “Enable rotate engrave” in the output tab in the RDworks software otherwise the next user will find their engraving and cutting will be stretched along the y-axis

Reset the laser (reset button on the controller) so it can relearn its home position, ready for the next user.

Also you can refer to the video of how the rotary axis works in our website:

<http://www.thunderlaser.com/how-to-use-your-laser-machine/how-the-rotary-axis-works.html>

4.10 For Laser Engraving

The engraving depth can easily be varied through the laser power or the speed. To increase the engraving depth, reduce the speed or increase the power setting. This way you increase the amount of energy per area unit. Engraving too deep, however, reduces the quality of the details. With coated materials the required power depends of the kind and thickness of the coating. With power set too high the individual lines become too thick and a sharp picture cannot be achieved. The resolution of the graphics should usually be at 500 dpi. The dpi setting (number of laser dots per inch) depends on the material. The lower this setting is, the lower the resolution of the engraved picture will be. This, however, reduces flaming and increases the energy of a pulse, which can improve the overall result (e.g. when engraving some sorts of plastic materials).

1. Plastics

Plastics for engraving are available in many different colors and thicknesses and with many different coatings and surfaces. The majority of available plastics can be well engraved and cut with the laser. Plastics with a micro-porous surface seem to give the best result, because less surface material needs to be removed. As most plastic materials have a low melting point, a low pip setting should be selected to reduce the danger of melting.

2. Acrylic

There are two different types of acrylic – cast and extruded. The cast acrylic becomes white or mat after engraving, the extruded acrylic remains clear. Use extruded acrylic for engravings that are filled with paint and cast acrylic for normal engravings. Cast acrylic can be best engraved without protection foil. It is better to engrave the entire surface with a low energy setting.

3. Engrave the rubber stamp

The various mixtures and densities of rubber plates cause a slightly varying engraving depth. The settings in the overview table give a good indication. Since engraving a standard rubber material requires a relatively high laser power, the laser power is principally set to 40% or more high and only the speed is varied. Due to their lower density, so-called micro porous rubber materials allow a significantly higher engraving speed. Test the rubber first, to find out the correct speed setting.

The RDWorksV8 software using the engraving function, you can choose “Ramp Effect” or common engraving, once you choose “Ramp Effect” and you will need to set a minimum power lower than Max Power, generally we set it to about 15%, and input a value with the Ramp Length what you want, but if you want to make it better, you may need to test different kinds of power and speed by yourself, then you can get the best result.

Engraving rubber produces a considerable amount of dust and terrible gas. Therefore a well-dimensioned exhaust system and its regular maintenance are very important.

Chapter 5 Maintenance

5.1 Cleaning the Laser Machine



1. Caution – use of controls or adjustments or performance of procedures other than those specified here in may result in hazardous laser radiation exposure.
2. Before starting cleaning and maintenance work always switch off the device and unplug the mains plug.
3. Always keep the system clean, as flammable parts in the working area or exhaust area rise the fire hazard.

Tips: You should check at least once a day, whether dust has accumulated in the engraving system. In case of soiling the machine must be cleaned. The cleaning interval strongly depends on the material that is being processed and the operating time of the device. Please bear in mind that only a clean machine guarantees optimal performance and reduces the service costs.

General Cleaning Notes:

1. Make sure, that the device is switched off and unplugged. Open the protective cover.
2. Move the working table into a position in which it is easiest for you to clean the surface with a window cleaning agent and paper towels.
3. Thoroughly remove all loose dirt particles and deposits in the interior of the machine.
4. Clean the cover of the laser tube.
5. You can clean the viewing window with a cotton cloth. Do not use paper towels as they could scratch the acrylic.

5.2 Cleaning the Optical Parts

The lens has a durable multi-coating and won't be damaged by correct and careful cleaning. You should inspect the focus lens and the mirrors and the beam combiner according the maintenance plan. If you discover a veil of haze or dirt, you must clean them.



It is suggested to clean the mirrors/lens before work every day in order to run the machine at max efficiency.







Follow the instructions below for the cleaning of optical parts:

5.2.1 Cleaning the Focus Lens

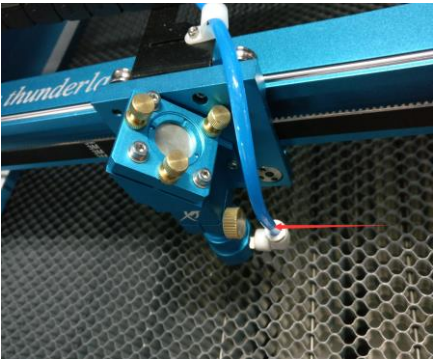
1. Move the engraving table to a distance approx. 10 cm under the lens holder.
2. Move the working head into the center of the working surface and put a cloth under the lens holder (so that the lens is not damaged if it accidentally falls out of its holder).
3. Now you can unscrew the lens holder.
4. Once positioned over a clean lens cleaning tissue, remove the lens from the lens holder by carefully turning the lens holder and letting the lens and the O-ring drop onto the cleaning cloth.
5. Examine the O-ring and, if necessary, clean it with a cotton bud and a lens cleaning tissue/cloth.
6. Remove the coarse dust as good as possible by blowing air onto the lens surface.
7. Check the surface and if necessary clean the lens with the lens cleaning liquid and lens tissue.
8. Hold the lens assembly by its edge with a lens cleaning tissue and use a drop of lens cleaning liquid from the little bottle which you received as an accessory delivered with the laser. While holding the lens on an angle, flush both surfaces of the lens, to wash away coarse soiling.
9. Put the lens on a clean lens cleaning tissue. Put some lens cleaning liquid on one side of the lens. Leave the liquid to take effect for approximately one minute and then gently wipe it away with lens cleaning tissues soaked with lens cleaning liquid.
10. Finally, dry this side of the lens with dry lens cleaning tissues and repeat the cleaning process on the other side of the lens. Never use a cleaning tissue twice. Dust accumulated in the cleaning tissue could scratch the lens surface.
11. Examine the lens. If it is still soiled, repeat the cleaning process until the lens is clean.
12. Carefully insert the lens into the lens holder. Ensure, that the rounded side (= convex) of the lens is facing upwards. Then put the O-ring on top of the lens.
13. Carefully assemble the lens in reverse order.

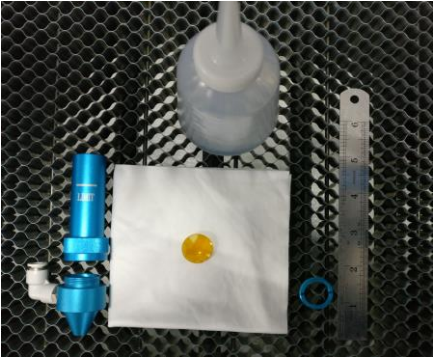

How to take out the focus lens, please just as following the picture indicated:

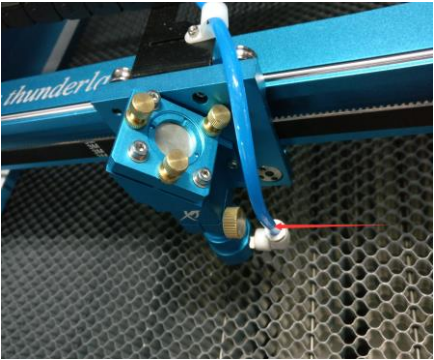
<p>1</p> 	<p>2</p> 
<p>Remove the air pipe.</p>	<p>Rotation of the left, and the head is divided into two parts.</p>
<p>3</p> 	<p>4</p> 
<p>Direction of rotation.</p>	
<p>5</p> 	<p>6</p> 
<p>Installation and please concave downward (convex side of the lens is facing upwards).</p>	<p>Fixed back the focus lens, and please be careful not to scratch the lens, then merge both parts together.</p>
<p>7</p> 	
<p>Reinstall the air pipe.</p>	

5.2.2 Cleaning the Mirrors

There are three mirrors in the operating area of the laser, which may have to be cleaned if they are soiled. To clean the reflector, follow the instructions below.

The Mirror#1



The mirrors are easily get dirty. And this will reduce the efficiency of the laser beam. Meanwhile, laser energy absorbed by the mirror may cause heat and destroy the mirrors too. For the first mirror, you can clean them directly.

The Mirror#2

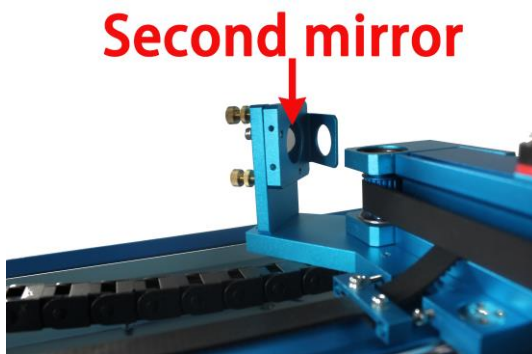

Make sure the power of the laser machine is turned off while cleaning. The 2nd mirror is installed on the left side of X rail. For the second mirror, you can clean them directly.

The Mirror#3



Cautions:

- 1) Mirrors must be cleaned carefully by using lens cleaning paper/lens cleaning cloth to avoid scratching the surface.
- 2) Do not touch the surface of the mirrors/lens after cleaning
- 3) The concave side of the lens must be on the bottom when installed

How to take out the mirror#1 #2 and#3, and please just as following the picture indicated:

1. The mirror#1

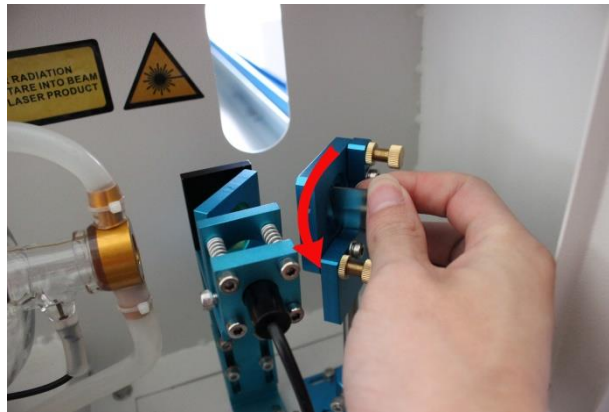

2. The mirror#2



3. The mirror#3





5.2.3 Cleaning Laser Combiner



- ① The beam combiner must be cleaned carefully by using lens cleaning paper/lens cleaning cloth to avoid scratching the surface.
- ② Do not touch the surface of the beam combiner after cleaning.
- ③ For the beam combiner, you can clean them directly.

5.3 Maintain the X/Y/Z Rails

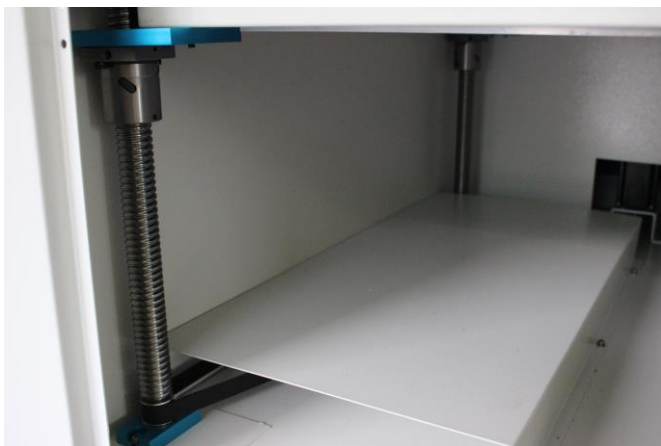

It is suggested to add lubricant oil (or Rust Preventative Grease) to the rails/screws at least every two weeks.

5.4 Check the Beam Path

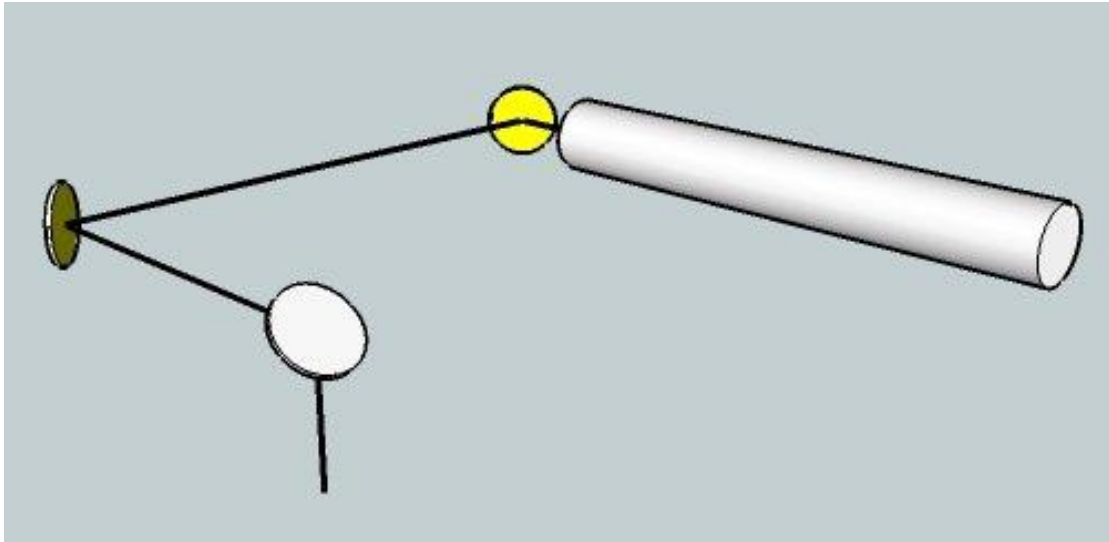

After being used for a long time, the beam path might be deflective. This will reduce the efficient of the laser beam or even cause no laser beam. At this moment, you will need to re-adjust the beam path again.

If you need to know that about adjust the laser beam path of the video on YouTube released by our company and please link to the URL:

<http://www.thunderlaser.com/how-to-use-your-laser-machine/how-to-adjust-the-laser-beam-path.html>

5.5 Change Cooling Water for The Water Chiller



It is suggested to change the water at least once every month

Make sure the laser tube is filled with water before starting the machine. It is advised to add water every 3 days.

The quality and temperature of the cooling water affects the life time of the laser tube. You need to use pure(distilled) water and control the temperature below 35°C (95°F) .

5.6 Maintenance Plan

1. DAILY CHECK LIST

- ① Check Mirrors and lens for condensation and make sure it is clean after work
- ② Check exhaust grille to ensure there is no blockage for exhaust fan
- ③ Check coolant water level
- ④ Check air filter on compressor
- ⑤ Ensure cooling fans on sides are free from debris
- ⑥ The air blower must be checking and cleaning if required.

2. WEEKLY CHECK LIST

- ① Clean filters on water chiller
- ② Clean debris from under laser bed
- ③ Clean X & Y & Z axis rails and lubricate as required
- ④ Clean Acrylic/Tempered glass covers in lid
- ⑤ The beam combiner must be checking every weekly, and cleaning if required.

THE END